

EXPANDER SYSTEM PIVOT PIN

PREVENT THE FORMATION OF LUG WEAR







PIVOT PIN ENGINEERING EXPERTISE

In the world of heavy industry, where massive machines, vehicles and equipment build and shape our civilization, details matter – including the pivot joints on your excavators and heavy vehicles. Lug wear leads to equipment breakdown, which results in downtime, production shortfalls and in the worst case scenario, injury. Construction, mining and forestry companies across the globe need a solution that permanently eliminates lug wear and empowers them to meet the challenges of everyday industrial operations. At Expander System, we develop and deliver those solutions 24/7.

It all started in the 1950s, when twin brothers Everth and Gerhard Svensson were hard at work building roads across the Swedish countryside. One day, when a pivot pin was pushing loose again, a frustrated Everth popped a nail in the lughole and the idea for the Expander System was born.

Today, we are the global leader in pivot pin technology and we are on a mission to reset the limits of industrial operations. From the award-winning design of our solutions and the fail-safe delivery of our products, to the way we tackle each individual customer challenge – we will find the perfect pivot pin solution for you.

ON A MISSION TO REDEFINE PERMANENT

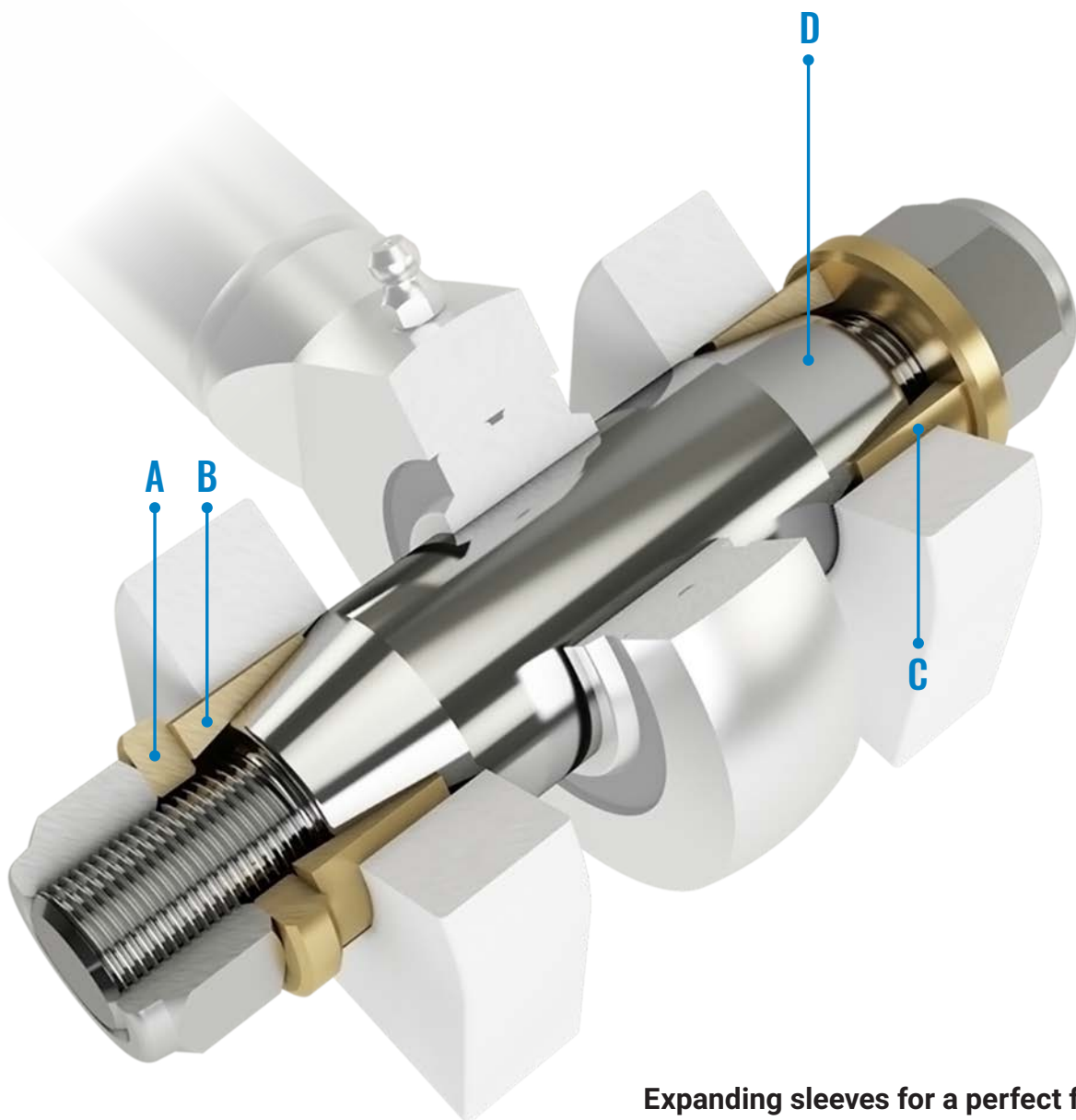

Expanding sleeves for a perfect fit

The Expander System consists of an assembly that includes: an axle tapered at both ends, two expansion sleeves, two tension washers and two fasteners.



How it works

A

Upon tightening the fasteners, the washer presses the slotted expansion sleeve up the tapered ends of the pin.

B

The sleeves expand, conform to the lugs and lock the system in place.

C

Once retorqued, the system locks from both sides and significantly increases stability.

D

The tapered axle makes it easy to remove and reinstall compared to traditional straight pins.

Benefits of the Expander System

- Permanent solution to lug wear
- Quick and easy to install and remove
- Increased life expectancy of bushings, bearings and seals
- Increased safety against breakage
- Machine parts that are cheaper and easier to use

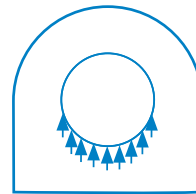

**EXPANDER SYSTEM
FORCE ON LUG**

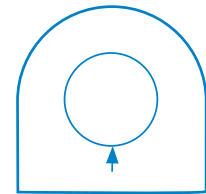

**TRADITIONAL STRAIGHT
PIN FORCE ON LUG**

Pressure distribution is key

The pressure distribution from the pivot pin onto the lug can be described by the Hertz contact formula.

A conventional system only distributes the load onto a very small area, due to the play needed to mount the pin into the lug. The Expander System distributes the pressure over the whole contact area in the direction of the force.

Winner of the Swedish Innovation Development Award

The Expander System is a recipient of the Swedish Innovation Development Award, in memory of Alfred Nobel. The award was presented by the Swedish Minister of Industry.



The Expander System can also be combined with Nord-Lock washers for vibration-intense applications.

THE EXPANDER DIFFERENCE

Experts in the design and manufacture of machinery deserve to partner with experts in pivot pin technology. Whatever your machine, industry or application, we will create the perfect pivot pin from the first installation.

Lower your costs and produce a smarter machine

- No need for additional fastening holes, threads or welding of locking ring on the machine
- No need for fine machining in the lugs as the Expander System makes it possible to use wide tolerances (H9 and Ra <3,2)
- No need for surface preparation
- Tapered axle ends and possibility for oversized lug holes makes axle assembly and removal very easy
- Less axle stress
- Axial stabilizing effect by strong double sided locking
- Up to 5 times longer service life of bushings and bearings compared to a straight pin due to less pivot movement

OEM first fit advantages

- Increase your customer satisfaction with a permanent solution to lug wear
- Offer your customers the market's best lifetime and total cost solution
- Access technical support from an engineering team that understands your pivot issues
- Safety stock handling
- Access all pivot pin designs, place orders and follow production stages in the web shop
- Order tracking

MAXIMIZE SAFETY AND MINIMIZE THE RISK OF AXLE BREAKAGE

Replacing a traditional straight pin with an Expander System pivot pin of the same diameter maximizes safety and minimizes the risk of axle breakage. The system's double sided axial locking makes a stronger machine.

Approx. **Expander System**
Load case: **Fixed supports**

The axle ends are fixed in the lugs by the expanding sleeves and the load case cuts the axle stress in half.

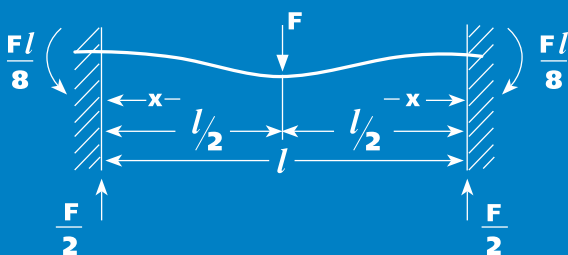

Stress at ends $\frac{F}{8W_{el}}$ At load $-\frac{F}{8W_{el}}$

These are the maximum stresses and are equal and opposite. Stress is zero at $x = \frac{1}{4}l$

Approx. **Traditional straight pin**
Load case: **Simple supports**

The axle ends are only supported from the bottom due to the play needed during installation.

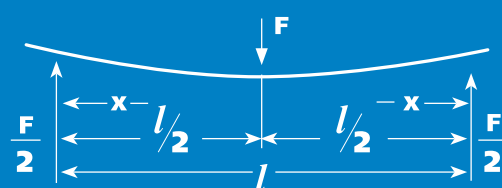

$\frac{F}{4W_{el}}$

Stress at center. If cross-section is constant, this is the maximum stress.

F = Force, W_{el} = section modulus (also known as S or Z).

Basic illustration of

EXPANDER SYSTEM VERSUS TRADITIONAL STRAIGHT PIN

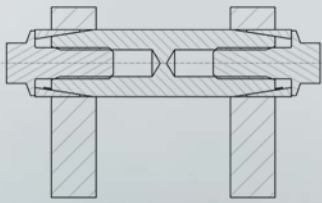

Expander System

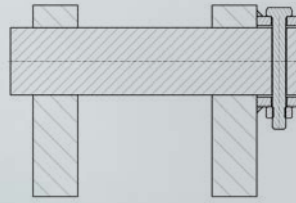

Traditional straight pin with locking ring



Traditional straight pin with flag washer

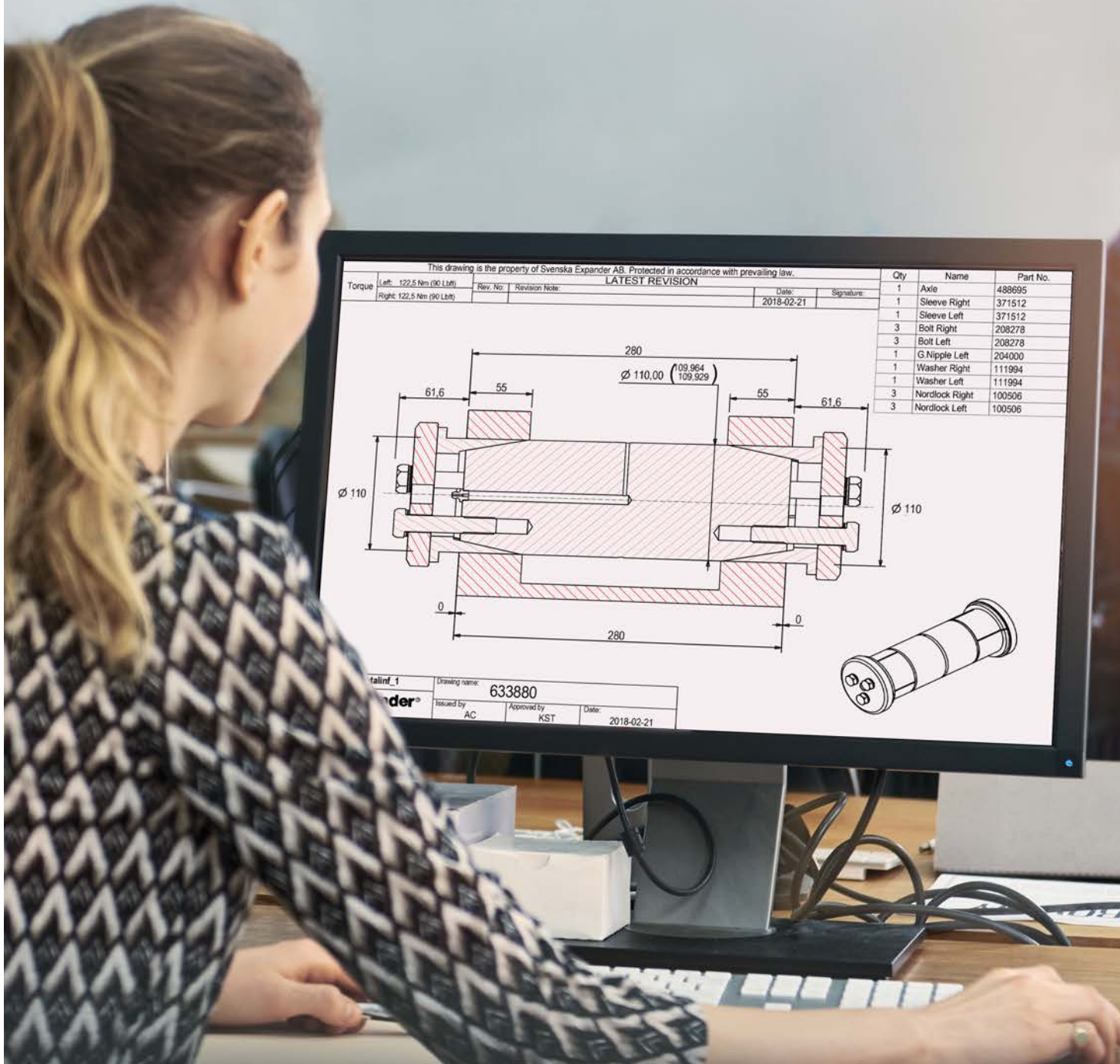

This drawing is the property of Svenska Expander AB. Protected in accordance with prevailing law.

Torque	Left: 122,5 Nm (90 Lbf-ft)	Rev. No.	Revision Note:	Date:	Signature:
	Right: 122,5 Nm (90 Lbf-ft)		LATEST REVISION	2018-02-21	

Qty	Name	Part No.
1	Axle	488695
1	Sleeve Right	371512
1	Sleeve Left	371512
3	Bolt Right	208278
3	Bolt Left	208278
1	G Nipple Left	204000
1	Washer Right	111994
1	Washer Left	111994
3	Nordlock Right	100506
3	Nordlock Left	100506

talinf_1	Drawing name:	633880
Expander®	Issued by:	AC
	Approved by:	KST
	Date:	2018-02-21

NO MORE LUG WEAR — EVER

The Expander System is perfect for repairs. Even if the lugs are badly worn, a repair can be made in the field with minimum downtime. If the lugs are worn, the sleeves simply expand to conform with the wear pattern and lock the system in place without the need for time consuming and expensive welding and line boring — just retorque.

In the Expander web shop you can get information on delivery lead time, order and find examples of the many pivot pin positions we have produced.

Please visit our web shop:
nord-lock.com/shop-expander

Aftermarket advantages

- Spare parts can be supplied regardless of the age of the equipment
- Greasing through the axle allows you to change to an automatic lubrication system
- Short lead times
- Access all pivot pin designs, place orders and follow production stages in the web shop
- Order tracking





COST SAVINGS FOR WORKSHOPS AND CUSTOMERS

SOLUTION USING LINE BORING AND TRADITIONAL STRAIGHT PIN

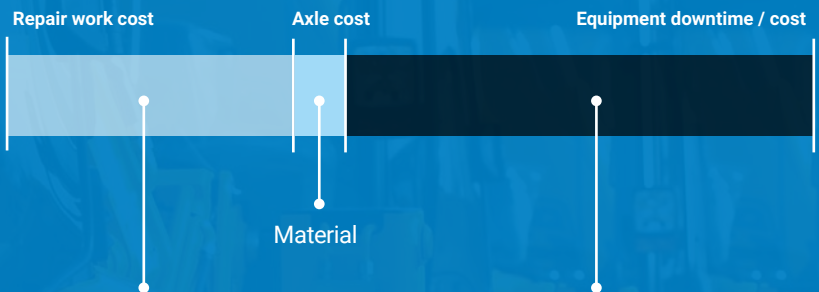

- 1 Remove existing pin
- 2 Mount line bore equipment
- 3 Line bore (make the lug hole round)
- 4 Weld the lug hole
- 5 Line bore (to right tolerance)
- 6 Remove the line bore equipment
- 7 Paint/repair after equipment
- 8 Mount new pin

- Time to drive to workshop
- Time to do all the repair steps
- Time to drive to work site
- Cost for replacement machine

SOLUTION USING EXPANDER SYSTEM

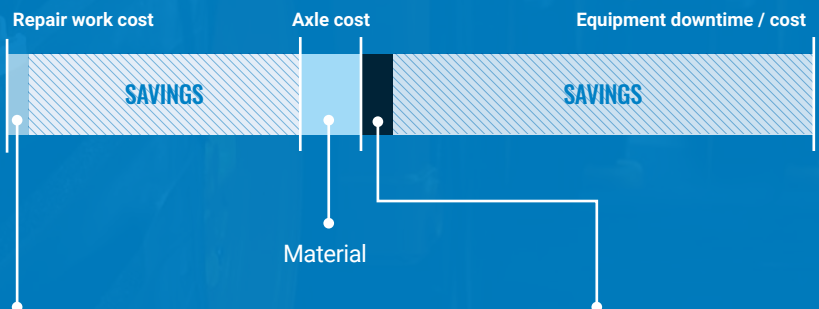

- 1 Remove existing pin
- 2 Mount Expander System

Time to retorque

A PIVOT PIN FOR ANY CHALLENGE

The widest product range in the industry

Expander System provides advanced, cost-effective pivot pin solutions that prevent lug wear — once and for all. We have the widest product range in the industry that has been installed in more than 10,000 machines. The Expander System software enables quick and easy customization of designs for new applications. Our production sites ensure swift, reliable delivery worldwide.

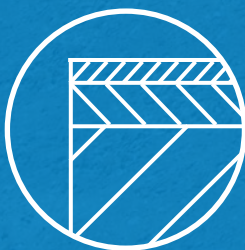

CUSTOM SOLUTIONS

Custom Expander System pivot pins are specifically adapted to suit your needs, including materials, hardening treatments, surface coatings and tolerances. Our products are always produced using the highest quality materials and we perform rigorous testing to ensure they meet your expectations for fast installation and removal.

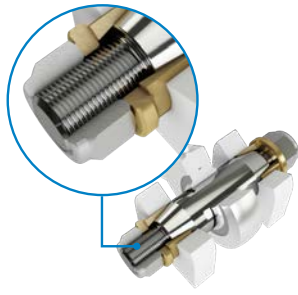

NUT AND WASHER

For applications with no obstacles around the pivot joint

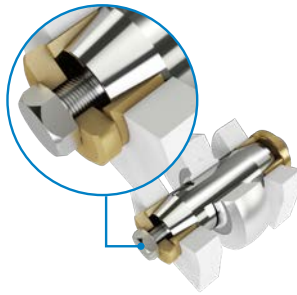

BOLT FASTENER WITH WASHER

For applications with no obstacles and pivot joint diameters ≥ 38 mm

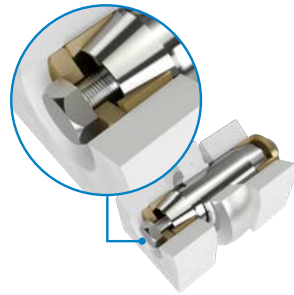

BOLT FASTENER WITH RECESSED WASHER

For applications with moving obstacles and a large lug width



THROUGH BOLT DESIGN

For applications with space constraints on one side

Axle variant	External thread	Internal thread	Internal thread	Through bolt
Fastener Side 1/Side 2	Hex nut/Hex nut	Hex head bolt /Hex head bolt	Hex head bolt /Hex head bolt	Hex head through bolt /Flush mount fastener
Obstacles outside lugs Side 1/Side 2	No obstacle/No obstacle	No obstacle/No obstacle	Moving obstacle /No obstacle	No obstacle /Fixed obstacle
Greasing of pivot	External or Internal greasing	External or Internal greasing	External or Internal greasing	External or Internal greasing
Standard pin \varnothing-range	$\varnothing 15$ mm–100 mm	$\varnothing 38$ mm–160 mm	$\varnothing 38$ mm–160 mm	$\varnothing 25$ mm–160 mm
Pin length	< 2000 mm	< 2000 mm	< 2000 mm	< 500 mm
Special	Upon request	Upon request	Upon request	Upon request

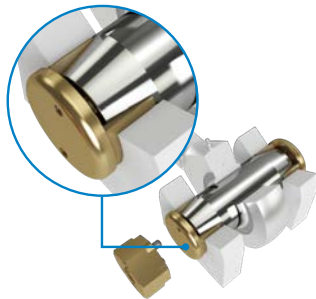

FLAT HEAD FASTENER

For applications with moving obstacles and a narrow lug width

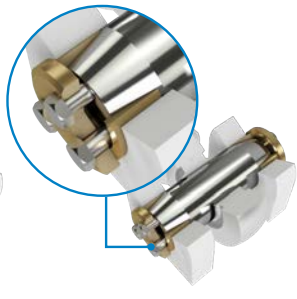

MULTI-BOLT ARRANGEMENT

For heavy-duty applications and large diameters

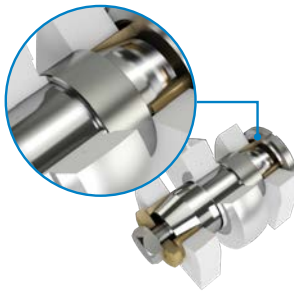

STEPPED PIN WITH AXIAL LOCKING

With axial locking for hitch pin applications

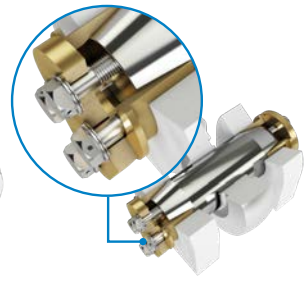

OFFSHORE

For offshore applications; DNV 2:22/ OS E-101 and API 8C/ISO 13535 norms

Axle variant	Internal thread	Multi-bolt internal thread	Internal thread	Internal thread
Fastener Side 1/Side 2	Flush mount fastener + mounting tool/Flush mount fastener + mounting tool	Multi-hex head bolt /Multi-hex head bolt	Hex head bolt /Hex head bolt + spanner nut	Hex head bolt /Hex head bolt
Obstacles outside lugs Side 1/Side 2	Moving obstacle /Moving obstacle	No obstacle/No obstacle	No obstacle/No obstacle	No obstacle/No obstacle
Greasing of pivot	External or Internal greasing	External or Internal greasing	External or Internal greasing	External or Internal greasing
Standard pin \varnothing-range	$\varnothing 40$ mm–160 mm	$\varnothing 70$ mm–400 mm	$\varnothing 38$ mm–160 mm	$\varnothing 20$ mm–400 mm
Pin length	< 2000 mm	< 2000 mm	< 1000 mm	< 2000 mm
Special	Upon request	Upon request	Upon request	Upon request

MORE POWER BEHIND YOUR PRODUCTIVITY

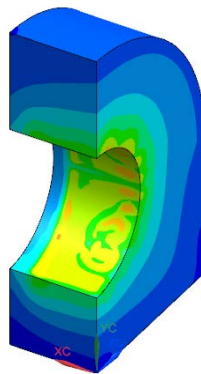

From structural strength calculations to the dimensioning and production of your complete pivot pin axle – our personalized service will accompany you throughout the pivot pin creation process. With your pivot pin project in safe hands, you can dedicate more time to other areas of the machine building process.

Heavy machinery and Expander System – the perfect match

Certificates and approvals:

- DNV
- TÜV
- ISO:9001
- ISO:14001

We can deliver certificates and testing according to your needs. For example, 3.1 material certificates or Ultrasonic, Magnetic particle and Charpy testing.

Field tested and certified

The patented Expander System has been endurance tested for over 50,000 hours without failure and over 1 million Expander System pivot pins have been installed in more than 60,000 types of applications.

Our know-how ensures each pivot pin system performs as expected from the moment it is installed until the end of its intended life cycle, giving you more machine uptime and lower maintenance costs.



Traceability

All Expander System pivot pins are marked with a lot number traceable to steel quality and manufacturing order. It is possible to mark the axles with your brand to let your customers know that you take pride in the details.



The industry's first full Lifetime Warranty

We are the only manufacturer in the industry with a 10-year or 10,000-hour warranty.



WE HAVE CUSTOMERS IN EVERY INDUSTRY



CONSTRUCTION



STEEL



RAILWAY



BRIDGE
BUILDING



FORESTRY &
AGRICULTURE



MINING &
QUARRYING



MANUFACTURING
& PROCESSING



ENERGY & POWER
GENERATION



SHIPBUILDING
& MARINE



OIL & GAS



MACHINE
BUILDING



TRANSPORTATION



LIGHTNING-QUICK DIGITAL DESIGN AND PRODUCTION



Expander System has optimized production lines for both high and low volume manufacturing. Our production facilities are equipped to enable high-speed manufacturing and delivery of complete pivot assemblies. We invest in the latest production technology to ensure maximum capability and quality, and we produce all parts of the pivot pin system. The Expander System software ensures fast and effective evaluation, design and production.

Quality assurance

Each Expander System pivot pin is inspected throughout the manufacturing process, prior to approval for release. With the latest in digital technology, we can control the entire process, from design to distribution, giving you the high-quality product, delivery and performance you deserve.

We speak your language

With several production facilities and technology centers, as well as sales representation all over the globe, we are never far from our customers. Whether you need general knowledge about our solutions, technical support, delivery of a customized pivot pin or one of our standard range solutions – we guarantee that it will be provided.







MINING & QUARRYING

Severe vibration of heavy machinery is a big challenge in mining. The Expander System is the most vibration-resilient pivot solution available, especially when combined with Nord-Lock wedge-locking washers. It significantly reduces maintenance and downtime in any mine or quarry.

Applications

- Loading and hauling equipment
- Drilling equipment
- Excavators
- Rock drills
- Special machines
- Mechanical scalers



CONSTRUCTION

Safety and productivity are paramount on any construction site, where the continuous operation of equipment and machines makes lug wear prevalent. The Expander System prolongs the lifetime of pivot joints, adding an extra layer of security to the job site and boosting productivity for a wide range of construction applications.

Applications

- Articulated haulers
- Excavators
- Dump trucks
- Snow ploughs
- Backhoes
- Wheel loaders
- Cranes
- Bulldozers



FORESTRY & AGRICULTURE

Forestry and agricultural machinery often work in isolated locations, far away from workshops and technical support. This makes them susceptible to long bouts of downtime if they break down. The Expander System is quick and easy to install and remove, allowing for on-site maintenance and substantially decreasing the production losses associated with downtime.

Applications

- Harvester heads
- Special equipment
- Skidders
- Feller bunchers
- Loading machines
- Sprayers
- Articulated Tractors
- Harvesters
- Loaders



OIL & GAS

The handling and setup of drilling equipment is an extremely important part of the oil and gas industry. The Expander System increases control and precision during setup, while enhancing safety on the rig or extraction site. DNV certified, the Expander System also minimizes maintenance and downtime.

Applications

- Hatches
- Pipe-handling systems
- Roughnecks
- Clevis
- Retractable dolly systems
- Cranes
- Top drives
- Dredgers
- Motion compensation machinery
- Visors
- Travel equipment
- Pipe racks
- Thrusters

A large industrial facility, likely a paper mill or steel mill, featuring a yellow crane with "S W L 25 TONNES" written on it. The floor is polished and reflective, and several large rolls of material are visible. A blue overlay contains text.

MANUFACTURING & PROCESSING

From paper mills to energy plants, optimized uptime is the goal, and constant motion is the challenge for pivot systems. The Expander System product range offers a wide variety of options to meet any manufacturing or processing need, including customized solutions for niche applications.

Applications

- **Paper mills** Cutter, sludge filter, center roller, jack-screw
- **Saw mills** Balers, intake, trimmer
- **Energy plant** Roaster, stoker feeder, grapple
- **Steel mills** Cooling bed, tensioning arm, oscillator machines, segment machines, side roller guides, side tensioner frame

OTHER SEGMENTS

- Wind
- Waste
- Railway
- Draw bridges
- Shipbuilding & Marine
- Transportation
- Material Handling



SAFEGUARDING HUMAN LIVES AND CUSTOMER INVESTMENTS

NORD-LOCK GROUP

In 1982, Nord-Lock developed the original wedge-locking technology that secures bolted joints. Since then, our family has grown to include a range of cutting-edge bolting technologies that together, provide the most comprehensive bolting solutions on the market.

Owned by Swedish investment group Latour, Nord-Lock Group is a global partner for all industries. We are present in 65 countries, with six production plants and six technical facilities around the world.

Nord-Lock Group is on a mission to make the world a safer place and help our customers go beyond what's possible. With a unique combination of bolting expertise and a comprehensive product range, we will provide you with the best solution for your bolting challenge.

NORD-LOCK®

Creator of the original wedge-locking washer technology and global leader in industrial washer solutions.

SUPERBOLT®

Inventor of the patented Superbolt multi-jackbolt tensioners, designed to eliminate unsafe bolting methods.

BOLTIGHT™

Pioneer in innovative hydraulic bolt tensioning, specializing in extreme environments.

Expander®

Leader in pivot pin technology, on a mission to end lug wear on industrial sites everywhere.



65+
COUNTRIES

25+
OFFICES WORLDWIDE

500+
EMPLOYEES

6
PRODUCTION PLANTS

6
TECHNICAL CENTERS

PIVOT PIN ENGINEERING EXPERTISE

Now it is your turn to make lug wear a thing of the past. Whatever challenges lug wear is causing your excavators, mobile cranes and dump trucks, we will work with you to maximize uptime and minimize maintenance costs.

Over 30-years of advancing and perfecting our pivot pin technology has given us unprecedented expertise in the sector. No matter your engineering challenge – Expander System has the perfect pivot pin solution for you.



00005EN - 2018-09

Expander System Sweden AB
Tel: +46 (0) 120 29900
Email: info@expander.se
www.expandersystem.com

Expander Americas Inc.
Toll-Free: +1-888-935-3884
Email: info@expandersystem.com
www.expandersystem.com

Nord-Lock Group
Tel: +46 40 602 46 00
Email: info@nord-lock.com
www.nord-lock.com