

**MITSUBISHI**

**GK16E**

ADVANCED MULTI-PURPOSE SYSTEM FOR CASING ADVANCEMENT

# ***ULTRA MAXBIT***

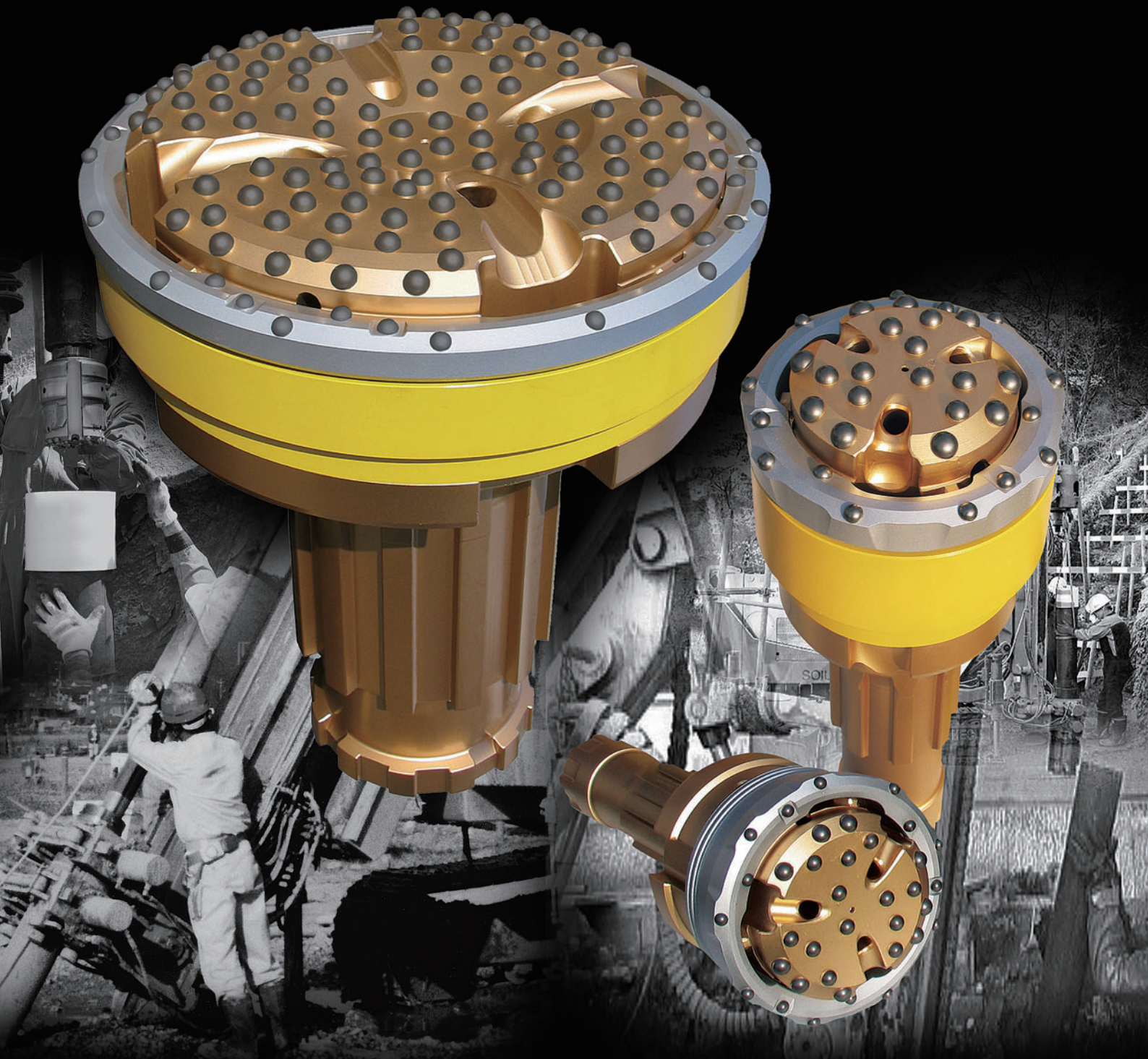

**MITSUBISHI MATERIALS**

# ULTRA MAXBIT

ADVANCED MULTI-PURPOSE SYSTEM FOR CASING ADVANCEMENT

## STRUCTURE AND FEATURE

### ● High speed and straight drilling in wide range of ground conditions

- ULTRA MAXBIT is used for simultaneous drilling and casing in unstable soft ground formations.
- ULTRA MAXBIT is also applicable for wide range of ground conditions such as sand, gravel and boulders and rock.
- The dual bit system also allows vertical, horizontal, and even inclined drilling.

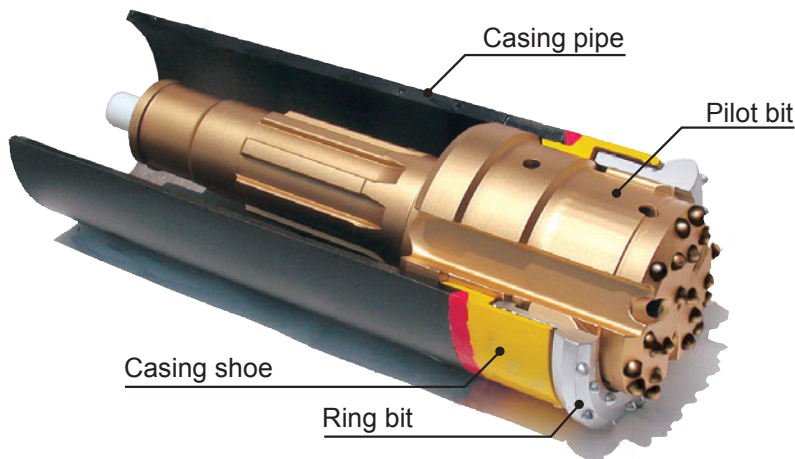

### ● Easy lock system

- Easy and speedy set-up.

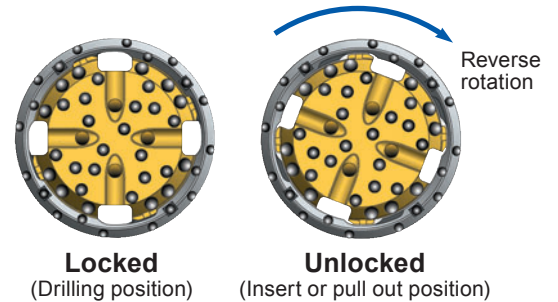

### ● Pilot bit

(Standard-connected to DTH Hammer)

- Pilot Bit is manufactured in three models, Single, Normal and Multi pass models.
- Twin impact shoulders.

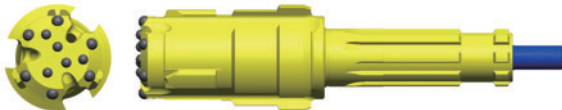

(Big Bore-connected to DTH Hammer)

- Big bore type is available.
- This new and improved model offers additional strength when drilling larger bore holes.
- Single impact shoulder.

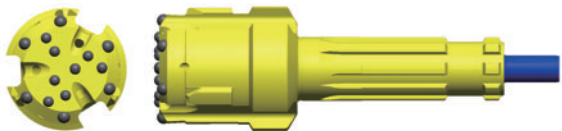

(Top hammer-connected to threaded rod)

- Top hammer type with R32, T38, T45, T51 thread is available.
- Twin impact shoulders.



### ● Stiff connecting structure between ring bit and casing shoe

(Thread connection type)

- Single pass model
- Normal model
- Top hammer model

\* Easy to assemble or disassemble at Job-site.

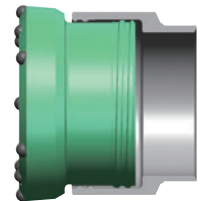

(Interlinked type)

- Multi use model
- Big bore model

\* Assembled in the factory cannot be disassembled.

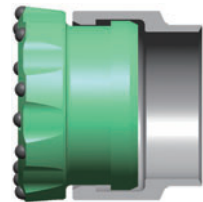

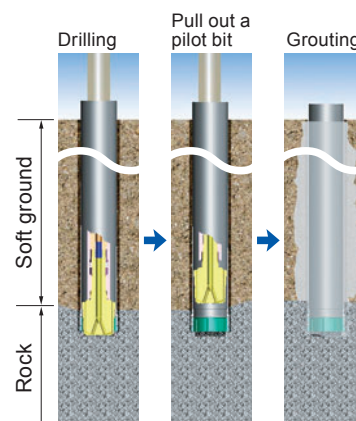

### ● Working types example

Fig.1 Piling construction (Permanent casing)

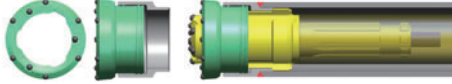
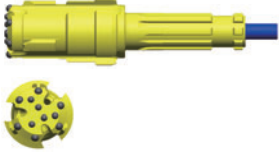
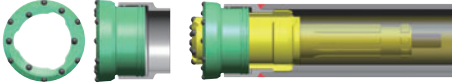
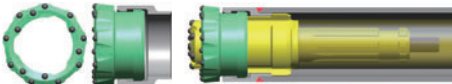
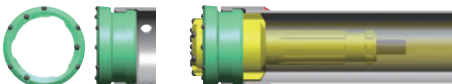
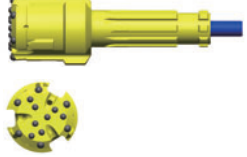
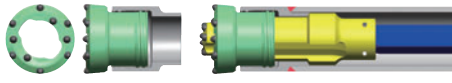

# OVERVIEW MAP

|                     | Model   | Pilot Bit  | Casing Type                 | Casing Outer $\varnothing$ mm (in.) | Application & Pile Type Example   |
|---------------------|---|--|-----------------------------|-------------------------------------|---|
| Standard-DTH System | <b>Single Pass Model</b> <ul style="list-style-type: none"> <li>• Suitable for relatively soft ground and short hole depth.</li> <li>• Leaving a casing pipe in the ground.</li> <li>• Thread connection ring set.</li> </ul>  | <b>For DTH Hammer</b>  <ul style="list-style-type: none"> <li>• Pilot Bit is manufactured in Single, Normal and Multi pass model as long as casing size is same.</li> </ul> | Permanent                   | 89.1–1016 (3 1/2"–40")              | • Piling construction ...Fig.1  |
|                     | <b>Normal Model</b> <ul style="list-style-type: none"> <li>• Suitable for heavy duty single pass and longer hole depth.</li> <li>• Leaving a casing pipe in the ground.</li> <li>• Thread connection ring set.</li> </ul>      |  | Permanent or *1 Retrievable | 114.3–457.2 (4 1/2"–8")             | • Piling construction ...Fig.1<br>• Water well ...Fig.2<br>• Geothermal ...Fig.2                              |
|                     | <b>Multi Use Model</b> <ul style="list-style-type: none"> <li>• Pulling force to remove casing is reduced.</li> <li>• This enables the casing pipe to be re-used.</li> <li>• Interlinked ring set.</li> </ul>                  |  | Retrievable                 | 89.1–1016 (3 1/2"–40")              | • Anchor construction ...Fig.3<br>• Foundation construction ...Fig.3  |
| Big Bore-DTH System | <b>Big Bore Model</b> <ul style="list-style-type: none"> <li>• Suitable for large bore drilling.</li> <li>• Interlinked ring set.</li> </ul>   | <b>For DTH Hammer</b>   | Permanent                   | 114.3–355.6 (4 1/2"–14")            | • Foundation construction ...Fig.1<br>• RD Pile *2 ...Fig.1<br>• Water well ...Fig.2<br>• Geothermal ...Fig.2 |
| Top Hammer System   | <b>Top Hammer Model</b> <ul style="list-style-type: none"> <li>• Suitable for small hole tunneling.</li> <li>• Thread connection ring set.</li> </ul>    | <b>For Top Hammer</b>   | Permanent                   | 76.3–139.7 (3"–5 1/2")              | • Pipe roof ...Fig.4<br>• Piling construction ...Fig.4  |

\*1 Limited to shallow hole drilling only.  
\*2 Refer to page 19.

**Fig.2** Water well and Geothermal

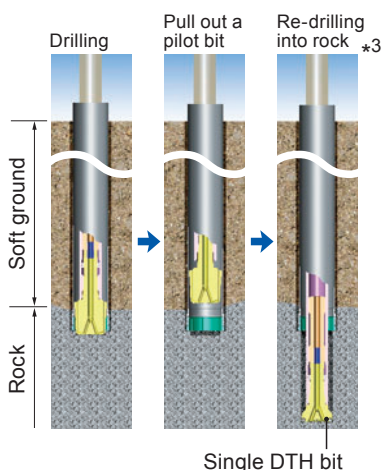

**Fig.3** Foundation construction (Temporary casing)

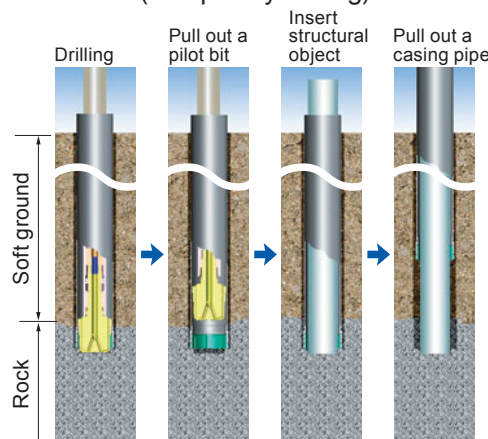

**Fig.4** Tunneling (Permanent casing)

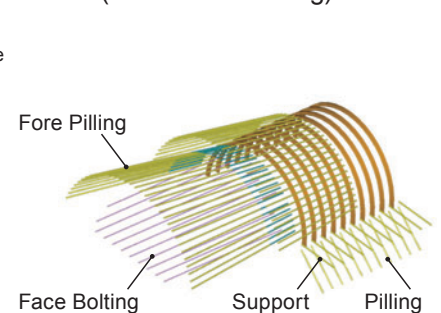

\*3 If hard ground is encountered, the ULTRA MAXBIT can be removed and drilling can be switched to a small diameter DTH BIT.

# DIMENSIONS

## Standard Type ULTRA MAXBIT / DTH

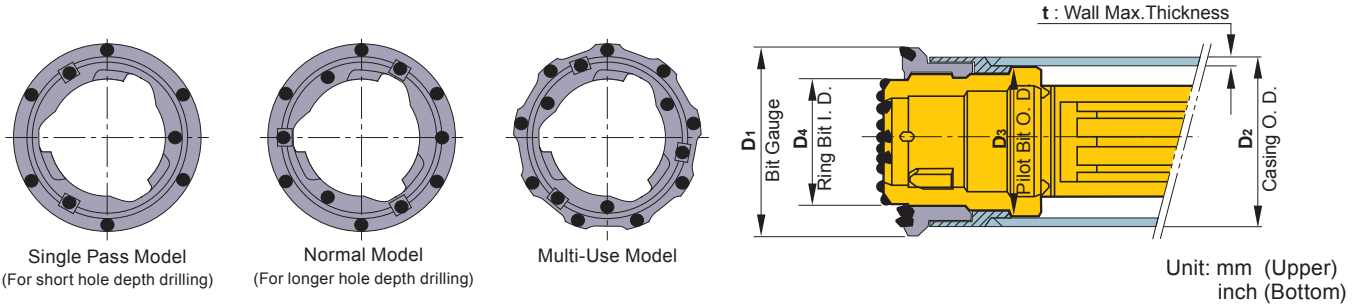

| Casing Pipe                          |                          | Type            | Ring Bit     |                              |                              | Pilot Bit                    |               |                                   | Ring Set (Ring Bit & Casing Shoe) | Compatible Part                     | System Part Number                  |                 |
|--------------------------------------|--------------------------|-----------------|--------------|------------------------------|------------------------------|------------------------------|---------------|-----------------------------------|-----------------------------------|-------------------------------------|-------------------------------------|-----------------|
| Outer Dia.<br>D <sub>2</sub>         | Wall Max. Thickness<br>t |                 | Model        | Inner Dia.<br>D <sub>4</sub> | Outer Dia.<br>D <sub>1</sub> | Outer Dia.<br>D <sub>3</sub> | Hammer        | Weight (kg)                       |                                   |                                     |                                     | Weight (kg)     |
| <b>CASING PIPE ø89.1mm (3 1/2")</b>  |                          |                 |              |                              |                              |                              |               |                                   |                                   |                                     |                                     |                 |
| 89.1<br>(3 1/2")                     | 6.3<br>(0.25")           | 056D            | Single pass  | 56<br>2.20"                  | 100<br>3.94"                 | 74<br>2.91"                  | DHD065        | 5.0                               | 2.7                               | US056D-02-R-266                     |                                     |                 |
|                                      | 7.0<br>(0.28")           | 059W            | Multi use    | 59<br>2.32"                  | 99<br>3.90"                  | 73<br>2.87"                  | DHD065        | 5.0                               | 2.4                               | UM059W-02-R-240                     |                                     |                 |
| <b>CASING PIPE ø114.3mm (4 1/2")</b> |                          |                 |              |                              |                              |                              |               |                                   |                                   |                                     |                                     |                 |
| 114.3<br>(4 1/2")                    | 10.0<br>(0.39")          | 072A            | Single pass  | 72<br>2.83"                  | 126<br>4.96"                 | 92<br>3.62"                  | DHD3.5        | 8.5                               | 4.7                               | US072A-03-BB-004<br>US072A-03-R-035 |                                     |                 |
|                                      |                          |                 |              | COP34                        |                              |                              | 9.1           |                                   |                                   |                                     |                                     |                 |
|                                      |                          |                 |              | COP32                        |                              |                              | 8.5           |                                   |                                   |                                     |                                     |                 |
|                                      |                          | 072A            | Normal       | 72<br>2.83"                  | 126<br>4.96"                 | 92<br>3.62"                  | DHD3.5        | 8.5                               | 4.7                               |                                     | UN072A-03-BB-005<br>UN072A-03-R-077 |                 |
|                                      |                          |                 |              | COP34                        |                              |                              | 9.1           |                                   |                                   |                                     |                                     |                 |
|                                      |                          |                 |              | COP32                        |                              |                              | 8.5           |                                   |                                   |                                     |                                     |                 |
|                                      | 072W                     | Multi use       | 72<br>2.83"  | 122<br>4.80"                 | 92<br>3.62"                  | DHD3.5                       | 8.5           | 4.4                               | 072A Pilot bit<br>UM072W-03-R-285 |                                     |                                     |                 |
|                                      |                          |                 | COP34        |                              |                              | 9.1                          |               |                                   |                                   |                                     |                                     |                 |
|                                      |                          |                 | COP32        |                              |                              | 8.5                          |               |                                   |                                   |                                     |                                     |                 |
|                                      | 8.0<br>(0.31")           | 072B            | Single pass  | 72<br>2.83"                  | 126<br>4.96"                 | 95.5<br>3.76"                | DHD3.5        | 8.7                               |                                   | 4.8                                 | US072B-03-R-090                     |                 |
|                                      |                          |                 |              | COP34                        |                              |                              | 9.3           |                                   |                                   |                                     |                                     |                 |
|                                      |                          |                 |              | COP32                        |                              |                              | 8.7           |                                   |                                   |                                     |                                     |                 |
|                                      |                          | 072B            | Normal       | 72<br>2.83"                  | 126<br>4.96"                 | 95.5<br>3.76"                | DHD3.5        | 8.7                               | 4.8                               | 072A Ring bit<br>UN072B-03-R-368    |                                     |                 |
|                                      |                          |                 |              | COP34                        |                              |                              | 9.3           |                                   |                                   |                                     |                                     |                 |
|                                      |                          |                 |              | COP32                        |                              |                              | 8.7           |                                   |                                   |                                     |                                     |                 |
|                                      | 072X                     | Multi use       | 72<br>2.83"  | 122<br>4.80"                 | 95.5<br>3.76"                | DHD3.5                       | 8.7           | 4.6                               | 072B Pilot bit<br>UM072X-03-R-369 |                                     |                                     |                 |
|                                      |                          |                 | COP34        |                              |                              | 9.3                          |               |                                   |                                   |                                     |                                     |                 |
|                                      |                          |                 | COP32        |                              |                              | 8.7                          |               |                                   |                                   |                                     |                                     |                 |
|                                      | 6.5<br>(0.26")           | 078W            | Multi use    | 78<br>3.07"                  | 124<br>4.88"                 | 98<br>3.86"                  | DHD3.5        | 9.5                               |                                   | 3.9                                 | UM078W-03-R-239                     |                 |
|                                      |                          |                 |              | COP34                        |                              |                              | 10.1          |                                   |                                   |                                     |                                     |                 |
|                                      |                          |                 |              | COP32                        |                              |                              | 9.5           |                                   |                                   |                                     |                                     |                 |
|                                      |                          | 6.35<br>(0.25") | 080A         | Single pass                  | 80<br>3.15"                  | 124<br>4.88"                 | 99.5<br>3.92" | DHD3.5                            | 9.7                               | 3.9                                 |                                     | US080A-03-R-341 |
|                                      |                          |                 |              |                              | COP34                        |                              |               | 10.3                              |                                   |                                     |                                     |                 |
|                                      |                          |                 |              |                              | COP32                        |                              |               | 9.7                               |                                   |                                     |                                     |                 |
| 080A                                 | Normal                   |                 | 80<br>3.15"  | 124<br>4.88"                 | 99.5<br>3.92"                | DHD3.5                       | 9.7           | 4.0                               | UN080A-03-R-249                   |                                     |                                     |                 |
|                                      |                          |                 | COP34        |                              |                              | 10.3                         |               |                                   |                                   |                                     |                                     |                 |
|                                      |                          |                 | COP32        |                              |                              | 9.7                          |               |                                   |                                   |                                     |                                     |                 |
| 080W                                 | Multi use                | 80<br>3.15"     | 128<br>5.04" | 99.5<br>3.92"                | DHD3.5                       | 9.7                          | 4.5           | 080A Pilot bit<br>UM080W-03-R-371 |                                   |                                     |                                     |                 |
|                                      |                          | COP34           |              |                              | 10.3                         |                              |               |                                   |                                   |                                     |                                     |                 |
|                                      |                          | COP32           |              |                              | 9.7                          |                              |               |                                   |                                   |                                     |                                     |                 |
| 6.0<br>(0.24")                       | 082A                     | Single pass     | 82<br>3.23"  | 126<br>4.96"                 | 100<br>3.94"                 | DHD3.5                       | 10.1          |                                   | 3.8                               | US082A-03-R-372                     |                                     |                 |
|                                      |                          |                 | COP34        |                              |                              | 10.7                         |               |                                   |                                   |                                     |                                     |                 |
|                                      |                          |                 | COP32        |                              |                              | 10.1                         |               |                                   |                                   |                                     |                                     |                 |
|                                      | 082A                     | Normal          | 82<br>3.23"  | 126<br>4.96"                 | 100<br>3.94"                 | DHD3.5                       | 10.1          | 3.9                               | UN082A-03-R-373                   |                                     |                                     |                 |
|                                      |                          |                 | COP34        |                              |                              | 10.7                         |               |                                   |                                   |                                     |                                     |                 |
|                                      |                          |                 | COP32        |                              |                              | 10.1                         |               |                                   |                                   |                                     |                                     |                 |
| 082W                                 | Multi use                | 82<br>3.23"     | 128<br>5.04" | 100<br>3.94"                 | DHD3.5                       | 10.1                         | 4.5           | 082A Pilot bit<br>UM082W-03-R-342 |                                   |                                     |                                     |                 |
|                                      |                          | COP34           |              |                              | 10.7                         |                              |               |                                   |                                   |                                     |                                     |                 |
|                                      |                          | COP32           |              |                              | 10.1                         |                              |               |                                   |                                   |                                     |                                     |                 |

Note 1) Normal model enables to be re-used in case of short hole drilling.

Note 2) To order, please advise the system type, casing size / hammer size and the ring bit models.

Note 3) Special types are also available according to customer's request.

# Standard Type ULTRA MAXBIT / DTH

## ● System Part Number

### U S 097A - 04 - R - 037

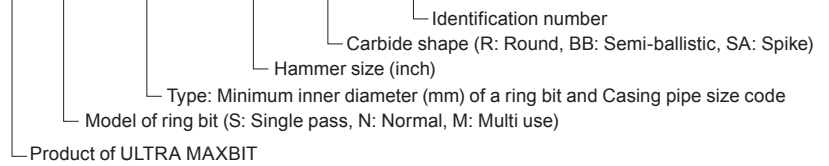

Unit: mm (Upper)  
inch (Bottom)

| Casing Pipe                                       |                          | Type      | Ring Bit    |                              |                              | Pilot Bit                    |        |             | Ring Set<br>(Ring Bit & Casing Shoe) | Compatible Part                 | System Part Number                  |                                     |
|---|--------------------------|-----------|-------------|------------------------------|------------------------------|------------------------------|--------|-------------|--------------------------------------|---------------------------------|-------------------------------------|-------------------------------------|
| Outer Dia.<br>D <sub>2</sub>                      | Wall Max. Thickness<br>t |           | Model       | Inner Dia.<br>D <sub>4</sub> | Outer Dia.<br>D <sub>1</sub> | Outer Dia.<br>D <sub>3</sub> | Hammer | Weight (kg) |                                      |                                 |                                     | Weight (kg)                         |
| <b>CASING PIPE ø127.0mm (5")</b>                  |                          |           |             |                              |                              |                              |        |             |                                      |                                 |                                     |                                     |
| 127.0<br>(5")                                     | 10.0<br>(0.39")          | 082X      | Multi use   | 82                           | 135                          | 105                          | DHD3.5 | 10.3        | 5.1                                  |                                 | UM082X-03-R-374                     |                                     |
|   |                          |           |             | 3.23"                        | 5.31"                        | 4.13"                        | COP34  | 10.9        |                                      |                                 |                                     |                                     |
|   | 8.8<br>(0.35")           | 084A      | Single pass | 84                           | 137                          | 107                          | DHD3.5 | 10.6        | 5.4                                  |                                 |                                     | US084A-03-R-103                     |
|   |                          |           |             | 3.31"                        | 5.39"                        | 4.21"                        | COP34  | 11.2        |                                      |                                 |                                     |                                     |
| <b>CASING PIPE ø133.0mm (5 15/64")</b>            |                          |           |             |                              |                              |                              |        |             |                                      |                                 |                                     |                                     |
| 133.0<br>(5 15/64")                               | 10.0<br>(0.39")          | 090W      | Multi use   | 90                           | 141                          | 110.5                        | DHD340 | 13.4        | 5.3                                  |                                 | UM090W-04-R-217                     |                                     |
|   |                          |           |             | 3.54"                        | 5.55"                        | 4.35"                        | QL40   | 14.7        |                                      |                                 |                                     |                                     |
|   |                          |           |             |                              |                              |                              | SD4    | 14.5        |                                      |                                 |                                     |                                     |
| <b>CASING PIPE ø139.7mm (5 1/2")</b>              |                          |           |             |                              |                              |                              |        |             |                                      |                                 |                                     |                                     |
| 139.7<br>(5 1/2")                                 | 10.0<br>(0.39")          | 097A      | Single pass | 97                           | 150                          | 117.5                        | DHD340 | 14.7        | 5.7                                  | 097A Pilot bit                  | US097A-04-BB-001<br>US097A-04-R-037 |                                     |
|   |                          |           |             | 3.82"                        | 5.91"                        | 4.63"                        | QL40   | 16.0        |                                      |                                 |                                     |                                     |
|   |                          | 097A      | Normal      | 97                           | 150                          | 117.5                        | DHD340 | 14.7        | 5.9                                  |                                 |                                     | UN097A-04-BB-002<br>UN097A-04-R-080 |
|   |                          |           |             | 3.82"                        | 5.91"                        | 4.63"                        | QL40   | 16.0        |                                      |                                 |                                     |                                     |
|   |                          | 097W      | Multi use   | 97                           | 147                          | 117.5                        | DHD340 | 14.7        | 5.6                                  |                                 |                                     | UM097W-04-R-286                     |
|   |                          |           |             | 3.82"                        | 5.79"                        | 4.63"                        | QL40   | 16.0        |                                      |                                 |                                     |                                     |
|   | 097X                     | Multi use | 97          | 147                          | 117.5                        | DHD340                       | 14.7   | 5.8         | UM097X-04-R-480                      |                                 |                                     |                                     |
|   |                          |           | 3.82"       | 5.79"                        | 4.63"                        | QL40                         | 16.0   |             |                                      |                                 |                                     |                                     |
|   | 8.0<br>(0.31")           | 105A      | Single pass | 105                          | 152                          | 125                          | DHD340 | 18.0        | 4.9                                  | 105A Pilot bit                  | US105A-04-R-101                     |                                     |
|   |                          |           |             | 4.13"                        | 5.98"                        | 4.92"                        | QL40   | 19.3        |                                      |                                 |                                     |                                     |
|   |                          | 105A      | Normal      | 105                          | 152                          | 125                          | DHD340 | 18.0        | 5.0                                  |                                 |                                     | UN105A-04-BB-025<br>UN105A-04-R-375 |
|   |                          |           |             | 4.13"                        | 5.98"                        | 4.92"                        | QL40   | 19.3        |                                      |                                 |                                     |                                     |
| 105W  |                          | Multi use | 105         | 150                          | 125                          | DHD340                       | 18.0   | 5.3         | UM105W-04-R-498                      |                                 |                                     |                                     |
|   |                          |           | 4.13"       | 5.91"                        | 4.92"                        | QL40                         | 19.3   |             |                                      |                                 |                                     |                                     |
| <b>CASING PIPE ø152.4mm (6")</b>                  |                          |           |             |                              |                              |                              |        |             |                                      |                                 |                                     |                                     |
| 152.4<br>(6")                                     | 10.0<br>(0.39")          | 110A      | Single pass | 110                          | 163                          | 130                          | DHD340 | 20.0        | 6.6                                  | 110A Pilot bit                  | US110A-04-R-039                     |                                     |
|   |                          |           |             | 4.33"                        | 6.42"                        | 5.12"                        | QL40   | 21.3        |                                      |                                 |                                     |                                     |
|   |                          | 110A      | Normal      | 110                          | 163                          | 130                          | DHD340 | 20.0        | 6.7                                  |                                 |                                     | UN110A-04-R-078                     |
|   |                          |           |             | 4.33"                        | 6.42"                        | 5.12"                        | QL40   | 21.3        |                                      |                                 |                                     |                                     |
|   |                          | 110W      | Multi use   | 110                          | 160                          | 130                          | DHD340 | 20.0        | 6.7                                  |                                 |                                     | UM110W-04-R-212                     |
|   |                          |           |             | 4.33"                        | 6.30"                        | 5.12"                        | QL40   | 21.3        |                                      |                                 |                                     |                                     |
| <b>CASING PIPE ø165.2mm (6 1/2")</b> (→Next page) |                          |           |             |                              |                              |                              |        |             |                                      |                                 |                                     |                                     |
| 165.2<br>(6 1/2")                                 | 7.1<br>(0.28")           | 128C      | Single pass | 128                          | 178                          | 149                          | DHD350 | 30.0        | 6.4                                  | 128A Pilot bit<br>128A Ring bit | US128C-05-R-376                     |                                     |
|   |                          |           |             | 5.04"                        | 7.01"                        | 5.87"                        | QL50   | 29.5        |                                      |                                 |                                     |                                     |
|   |                          | 128C      | Normal      | 128                          | 178                          | 149                          | DHD350 | 30.0        | 6.5                                  | 128A Pilot bit<br>128A Ring bit |                                     |                                     |
|   |                          |           |             | 5.04"                        | 7.01"                        | 5.87"                        | QL50   | 29.5        |                                      |                                 |                                     |                                     |
|   |                          | 128W      | Multi use   | 128                          | 180                          | 149                          | DHD350 | 30.0        | 7.6                                  | 128A Pilot bit<br>128A Ring bit |                                     |                                     |
|   |                          |           |             | 5.04"                        | 7.09"                        | 5.87"                        | QL50   | 29.5        |                                      |                                 |                                     |                                     |

To be continued

# DIMENSIONS

## Standard Type ULTRA MAXBIT / DTH

Unit: mm (Upper)  
inch (Bottom)

| Casing Pipe                          |                     | Type        | Ring Bit    |                |                | Pilot Bit  |        |             | Ring Set<br>(Ring Bit & Casing Shoe) | Compatible Part                 | System Part Number |                                 |                                 |                 |
|--------------------------------------|---------------------|-------------|-------------|----------------|----------------|------------|--------|-------------|--------------------------------------|---------------------------------|--------------------|---------------------------------|---------------------------------|-----------------|
| Outer Dia.                           | Wall Max. Thickness |             | Model       | Inner Dia.     | Outer Dia.     | Outer Dia. | Hammer | Weight (kg) |                                      |                                 |                    |                                 |                                 |                 |
| D <sub>2</sub>                       | t                   |             |             | D <sub>4</sub> | D <sub>1</sub> |            |        |             |                                      |                                 |                    | D <sub>3</sub>                  |                                 |                 |
| <b>CASING PIPE ø165.2mm (6 1/2")</b> |                     |             |             |                |                |            |        |             |                                      |                                 |                    |                                 |                                 |                 |
| 165.2<br>(6 1/2")                    | 6.0<br>(0.24")      | 128A        | Single pass | 128            | 178            | 149        | DHD350 | 30.0        | 8.0                                  |                                 | US128A-05-R-378    |                                 |                                 |                 |
|                                      |                     |             |             | 5.04"          | 7.01"          | 5.87"      | QL50   | 29.5        |                                      |                                 |                    |                                 |                                 |                 |
|                                      |                     | SD5         | 29.5        |                |                |            |        |             |                                      |                                 |                    |                                 |                                 |                 |
|                                      | 128A                | Normal      | 128         | 178            | 149            | DHD350     | 30.0   | 6.5         | UN128A-05-BB-026                     |                                 |                    |                                 |                                 |                 |
|                                      |                     |             | 5.04"       | 7.01"          | 5.87"          | QL50       | 29.5   |             |                                      |                                 |                    |                                 |                                 |                 |
|                                      |                     |             | SD5         | 29.5           |                |            |        |             |                                      |                                 |                    |                                 |                                 |                 |
| 5.0<br>(0.20")                       | 128B                | Normal      | 128         | 178            | 149            | DHD350     | 30.0   | 6.5         |                                      | 128A Pilot bit<br>128A Ring bit | UN128B-05-R-256    |                                 |                                 |                 |
|                                      |                     |             | 5.04"       | 7.01"          | 5.87"          | QL50       | 29.5   |             |                                      |                                 |                    |                                 |                                 |                 |
|                                      |                     |             | SD5         | 29.5           |                |            |        |             |                                      |                                 |                    |                                 |                                 |                 |
| <b>CASING PIPE ø168.3mm (6 5/8")</b> |                     |             |             |                |                |            |        |             |                                      |                                 |                    |                                 |                                 |                 |
| 168.3<br>(6 5/8")                    | 12.7<br>(0.50")     | 118A        | Single pass | 118            | 178            | 140        | DHD350 | 25.5        | 8.9                                  |                                 |                    |                                 | US118A-05-R-041                 |                 |
|                                      |                     |             |             | 4.65"          | 7.01"          | 5.51"      | QL50   | 25.0        |                                      |                                 |                    |                                 |                                 |                 |
|                                      |                     | SD5         | 25.0        |                |                |            |        |             |                                      |                                 |                    |                                 |                                 |                 |
|                                      |                     | 118A        | Normal      | 118            | 178            | 140        | DHD350 | 25.5        | 9.0                                  | UN118A-05-R-081                 |                    |                                 |                                 |                 |
|                                      |                     |             |             | 4.65"          | 7.01"          | 5.51"      | QL50   | 25.0        |                                      |                                 |                    |                                 |                                 |                 |
|                                      |                     |             |             | SD5            | 25.0           |            |        |             |                                      |                                 |                    |                                 |                                 |                 |
|                                      | 118W                | Multi use   | 118         | 175            | 140            | DHD350     | 25.5   | 8.0         | 118A Pilot bit                       |                                 | UM118W-05-R-377    |                                 |                                 |                 |
|                                      |                     |             | 4.65"       | 6.89"          | 5.51"          | QL50       | 25.0   |             |                                      |                                 |                    |                                 |                                 |                 |
|                                      |                     |             | SD5         | 25.0           |                |            |        |             |                                      |                                 |                    |                                 |                                 |                 |
|                                      | 10.0<br>(0.39")     | 126A        | Single pass | 126            | 178            | 146        | DHD350 | 27.0        |                                      | 7.5                             |                    |                                 | US126A-05-R-053                 |                 |
|                                      |                     |             |             | 4.96"          | 7.01"          | 5.75"      | QL50   | 26.5        |                                      |                                 |                    |                                 |                                 |                 |
|                                      |                     | SD5         | 26.5        |                |                |            |        |             |                                      |                                 |                    |                                 |                                 |                 |
|                                      |                     | 126A        | Normal      | 126            | 178            | 146        | DHD350 | 27.0        | 7.6                                  | UN126A-05-R-058                 |                    |                                 |                                 |                 |
|                                      |                     |             |             | 4.96"          | 7.01"          | 5.75"      | QL50   | 26.5        |                                      |                                 |                    |                                 |                                 |                 |
|                                      |                     |             |             | SD5            | 26.5           |            |        |             |                                      |                                 |                    |                                 |                                 |                 |
|                                      | 126W                | Multi use   | 126         | 175            | 146            | DHD350     | 27.0   | 7.1         | 126A Pilot bit                       |                                 | UM126W-05-R-379    |                                 |                                 |                 |
|                                      |                     |             | 4.96"       | 6.89"          | 5.75"          | QL50       | 26.5   |             |                                      |                                 |                    |                                 |                                 |                 |
|                                      |                     |             | SD5         | 26.5           |                |            |        |             |                                      |                                 |                    |                                 |                                 |                 |
| 8.0<br>(0.31")                       | 126B                | Single pass | 126         | 178            | 146            | DHD350     | 27.0   | 7.8         |                                      | 126A Pilot bit<br>126A Ring bit |                    | US126B-05-R-380                 |                                 |                 |
|                                      |                     |             | 4.96"       | 7.01"          | 5.75"          | QL50       | 26.5   |             |                                      |                                 |                    |                                 |                                 |                 |
|                                      | SD5                 | 26.5        |             |                |                |            |        |             |                                      |                                 |                    |                                 |                                 |                 |
|                                      | 126B                | Normal      | 126         | 178            | 146            | DHD350     | 27.0   | 7.9         | 126A Pilot bit<br>126A Ring bit      |                                 | UN126B-05-R-381    |                                 |                                 |                 |
| 4.96"                                |                     |             | 7.01"       | 5.75"          | QL50           | 26.5       |        |             |                                      |                                 |                    |                                 |                                 |                 |
| <b>CASING PIPE ø177.8mm (7")</b>     |                     |             |             |                |                |            |        |             |                                      |                                 |                    |                                 |                                 |                 |
| 177.8<br>(7")                        | 12.7<br>(0.50")     | 127A        | Single pass | 127            | 188            | 149        | DHD350 | 28.5        | 9.6                                  |                                 | US127A-05-R-043    |                                 |                                 |                 |
|                                      |                     |             |             | 5.00"          | 7.40"          | 5.87"      | QL50   | 27.5        |                                      |                                 |                    |                                 |                                 |                 |
|                                      |                     | SD5         | 27.5        |                |                |            |        |             |                                      |                                 |                    |                                 |                                 |                 |
|                                      |                     | 127A        | Normal      | 127            | 188            | 149        | DHD350 | 28.5        | 9.7                                  |                                 |                    | UN127A-05-R-079                 |                                 |                 |
|                                      |                     |             |             | 5.00"          | 7.40"          | 5.87"      | QL50   | 27.5        |                                      |                                 |                    |                                 |                                 |                 |
|                                      |                     |             |             | SD5            | 27.5           |            |        |             |                                      |                                 |                    |                                 |                                 |                 |
|                                      | 127W                | Multi use   | 127         | 186            | 149            | DHD350     | 28.5   | 9.1         | 127A Pilot bit                       | UM127W-05-R-287                 |                    |                                 |                                 |                 |
|                                      |                     |             | 5.00"       | 7.32"          | 5.87"          | QL50       | 27.5   |             |                                      |                                 |                    |                                 |                                 |                 |
|                                      |                     |             | SD5         | 27.5           |                |            |        |             |                                      |                                 |                    |                                 |                                 |                 |
|                                      | 11.5<br>(0.45")     | 127C        | Single pass | 127            | 188            | 149        | DHD350 | 28.5        |                                      |                                 | 9.7                | 127A Pilot bit<br>127A Ring bit | US127C-05-R-142                 |                 |
|                                      |                     |             |             | 5.00"          | 7.40"          | 5.87"      | QL50   | 27.5        |                                      |                                 |                    |                                 |                                 |                 |
|                                      | SD5                 | 27.5        |             |                |                |            |        |             |                                      |                                 |                    |                                 |                                 |                 |
| 10.0<br>(0.39")                      | 127X                | Multi use   | 127         | 186            | 149            | DHD350     | 28.5   | 9.5         | 127A Pilot bit                       | UM127X-05-R-382                 |                    |                                 |                                 |                 |
|                                      |                     |             | 5.00"       | 7.32"          | 5.87"          | QL50       | 27.5   |             |                                      |                                 |                    |                                 |                                 |                 |
| SD5                                  | 27.5                |             |             |                |                |            |        |             |                                      |                                 |                    |                                 |                                 |                 |
| 4.8<br>(0.19")                       | 142A                | Normal      | 142         | 188            | 164.5          | DHD360     | 38.5   | 7.1         |                                      | UN142A-06-R-131                 |                    |                                 |                                 |                 |
|                                      |                     |             | 5.59"       | 7.40"          | 6.48"          | QL60       | 38.0   |             |                                      |                                 |                    |                                 |                                 |                 |
| SD6                                  | 41.0                |             |             |                |                |            |        |             |                                      |                                 |                    |                                 |                                 |                 |
| <b>CASING PIPE ø190.7mm (7 1/2")</b> |                     |             |             |                |                |            |        |             |                                      |                                 |                    |                                 |                                 |                 |
| 190.7<br>(7 1/2")                    | 6.0<br>(0.24")      | 156A        | Single pass | 156            | 206            | 176.5      | DHD360 | 42.0        | 7.5                                  |                                 | US156A-06-R-155    |                                 |                                 |                 |
|                                      |                     |             |             | 6.14"          | 8.11"          | 6.95"      | QL60   | 41.5        |                                      |                                 |                    |                                 |                                 |                 |
|                                      |                     | SD6         | 44.5        |                |                |            |        |             |                                      |                                 |                    |                                 |                                 |                 |
|                                      |                     | 156A        | Normal      | 156            | 206            | 176.5      | DHD360 | 42.0        | 7.6                                  |                                 |                    | UN156A-06-R-383                 |                                 |                 |
|                                      | 6.14"               |             |             | 8.11"          | 6.95"          | QL60       | 41.5   |             |                                      |                                 |                    |                                 |                                 |                 |
|                                      | SD6                 | 44.5        |             |                |                |            |        |             |                                      |                                 |                    |                                 |                                 |                 |
|                                      | 5.3<br>(0.21")      | 156B        | Single pass | 156            | 206            | 176.5      | DHD360 | 42.0        | 7.6                                  |                                 |                    |                                 | 156A Pilot bit<br>156A Ring bit | US156B-06-R-384 |
|                                      |                     |             |             | 6.14"          | 8.11"          | 6.95"      | QL60   | 41.5        |                                      |                                 |                    |                                 |                                 |                 |
| SD6                                  |                     | 44.5        |             |                |                |            |        |             |                                      |                                 |                    |                                 |                                 |                 |
| 156B                                 |                     | Normal      | 156         | 206            | 176.5          | DHD360     | 42.0   | 7.7         | 156A Pilot bit<br>156A Ring bit      | UN156B-06-R-385                 |                    |                                 |                                 |                 |
|                                      | 6.14"               |             | 8.11"       | 6.95"          | QL60           | 41.5       |        |             |                                      |                                 |                    |                                 |                                 |                 |
| SD6                                  | 44.5                |             |             |                |                |            |        |             |                                      |                                 |                    |                                 |                                 |                 |

Note 1) Normal model enables to be re-used in case of short hole drilling.

Note 2) To order, please advise the system type, casing size / hammer size and the ring bit models.

Note 3) Special types are also available according to customer's request.

# Standard Type ULTRA MAXBIT / DTH

Unit: mm (Upper)  
inch (Bottom)

| Casing Pipe                            |                     | Type            | Ring Bit    |                |                | Pilot Bit      |        |                 | Ring Set<br>(Ring Bit & Casing Shoe) | Compatible Part                 | System Part Number                  |                 |
|--|---------------------|-----------------|-------------|----------------|----------------|----------------|--------|-----------------|--------------------------------------|---------------------------------|-------------------------------------|-----------------|
| Outer Dia.                             | Wall Max. Thickness |                 | Model       | Inner Dia.     | Outer Dia.     | Outer Dia.     | Hammer | Weight (kg)     |                                      |                                 |                                     | Weight (kg)     |
| D <sub>2</sub>                         | t                   |                 |             | D <sub>4</sub> | D <sub>1</sub> | D <sub>3</sub> |        |                 |                                      |                                 |                                     |                 |
| <b>CASING PIPE ø193.7mm (7 5/8")</b>   |                     |                 |             |                |                |                |        |                 |                                      |                                 |                                     |                 |
| 193.7<br>(7 5/8")                      | 12.7<br>(0.50")     | 143A            | Single pass | 143            | 206            | 166            | DHD360 | 38.0            | 10.5                                 |                                 | US143A-06-R-045                     |                 |
|  |                     |                 |             | 5.63"          | 8.11"          | 6.54"          | QL60   | 37.5            |                                      |                                 |                                     |                 |
|  |                     |                 | SD6         | 40.5           |                |                |        |                 |                                      |                                 |                                     |                 |
|  |                     | Normal          | 143         | 206            | 166            | DHD360         | 38.0   | 10.2            |                                      |                                 | UN143A-06-R-386                     |                 |
|  |                     |                 | 5.63"       | 8.11"          | 6.54"          | QL60           | 37.5   |                 |                                      |                                 |                                     |                 |
|  |                     |                 | SD6         | 40.5           |                |                |        |                 |                                      |                                 |                                     |                 |
|  | 143W                | Multi use       | 143         | 202            | 166            | DHD360         | 38.0   | 10.2            | 143A Pilot bit                       | UM143W-06-R-288                 |                                     |                 |
|  |                     |                 | 5.63"       | 7.95"          | 6.54"          | QL60           | 37.5   |                 |                                      |                                 |                                     |                 |
|  |                     |                 | SD6         | 40.5           |                |                |        |                 |                                      |                                 |                                     |                 |
|  | 11.0<br>(0.43")     | 151A            | Single pass | 151            | 206            | 170            | DHD360 | 40.0            | 9.1                                  |                                 | US151A-06-BB-013<br>US151A-05-R-075 |                 |
|  |                     |                 |             | 5.94"          | 8.11"          | 6.69"          | QL60   | 39.5            |                                      |                                 |                                     |                 |
|  |                     |                 |             | SD6            | 42.5           |                |        |                 |                                      |                                 |                                     |                 |
| 151W                                   |                     | Multi use       | 151         | 202            | 170            | DHD360         | 40.0   | 8.4             | 151A Pilot bit                       |                                 | UM151W-06-R-387                     |                 |
|  |                     |                 | 5.94"       | 7.95"          | 6.69"          | QL60           | 39.5   |                 |                                      |                                 |                                     |                 |
|  |                     |                 | SD6         | 42.5           |                |                |        |                 |                                      |                                 |                                     |                 |
| 6.0<br>(0.24")                         | 157A                | Single pass     | 157         | 209            | 180            | DHD360         | 43.5   | 9.2             |                                      | US157A-06-R-388                 |                                     |                 |
|  |                     |                 | 6.18"       | 8.23"          | 7.09"          | QL60           | 43.0   |                 |                                      |                                 |                                     |                 |
|  |                     |                 | SD6         | 46.0           |                |                |        |                 |                                      |                                 |                                     |                 |
|  | Normal              | 157             | 209         | 180            | DHD360         | 43.5           | 9.5    | UN157A-06-R-088 |                                      |                                 |                                     |                 |
|  |                     | 6.18"           | 8.23"       | 7.09"          | QL60           | 43.0           |        |                 |                                      |                                 |                                     |                 |
|  |                     | SD6             | 46.0        |                |                |                |        |                 |                                      |                                 |                                     |                 |
| <b>CASING PIPE ø216.3mm (8 33/64")</b> |                     |                 |             |                |                |                |        |                 |                                      |                                 |                                     |                 |
| 216.3<br>(8 33/64")                    | 8.2<br>(0.32")      | 175A            | Single pass | 175            | 231            | 197.5          | DHD360 | 51.5            | 10.2                                 |                                 | US175A-06-R-389                     |                 |
|  |                     |                 |             | 6.89"          | 9.09"          | 7.78"          | QL60   | 51.0            |                                      |                                 |                                     |                 |
|  |                     |                 | SD6         | 54.0           |                |                |        |                 |                                      |                                 |                                     |                 |
|  |                     | Normal          | 175         | 231            | 197.5          | DHD360         | 51.5   | 10.3            | 175C Ring bit                        |                                 | UN175A-06-R-390                     |                 |
|  |                     |                 | 6.89"       | 9.09"          | 7.78"          | QL60           | 51.0   |                 |                                      |                                 |                                     |                 |
|  |                     |                 | SD6         | 54.0           |                |                |        |                 |                                      |                                 |                                     |                 |
|  | 7.7<br>(0.30")      | 175B            | Single pass | 175            | 231            | 197.5          | DHD360 | 51.5            | 10.2                                 | 175A Pilot bit<br>175A Ring bit | US175B-06-R-277                     |                 |
|  |                     |                 |             | 6.89"          | 9.09"          | 7.78"          | QL60   | 51.0            |                                      |                                 |                                     |                 |
|  |                     |                 |             | SD6            | 54.0           |                |        |                 |                                      |                                 |                                     |                 |
|  | 7.0<br>(0.28")      | 175D            | Normal      | 175            | 231            | 197.5          | DHD360 | 51.5            | 10.5                                 | 175A Pilot bit<br>175C Ring bit | UN175D-06-R-391                     |                 |
|  |                     |                 |             | 6.89"          | 9.09"          | 7.78"          | QL60   | 51.0            |                                      |                                 |                                     |                 |
|  |                     |                 |             | SD6            | 54.0           |                |        |                 |                                      |                                 |                                     |                 |
| 5.8<br>(0.23")                         | 175C                | Normal          | 175         | 231            | 197.5          | DHD360         | 51.5   | 10.4            | 175A Pilot bit                       | UN175C-06-R-279                 |                                     |                 |
|  |                     |                 | 6.89"       | 9.09"          | 7.78"          | QL60           | 51.0   |                 |                                      |                                 |                                     |                 |
|  |                     |                 | SD6         | 54.0           |                |                |        |                 |                                      |                                 |                                     |                 |
| <b>CASING PIPE ø219.1mm (8 5/8")</b>   |                     |                 |             |                |                |                |        |                 |                                      |                                 |                                     |                 |
| 219.1<br>(8 5/8")                      | 12.7<br>(0.50")     | 170A            | Single pass | 170            | 231            | 191            | DHD360 | 49.0            | 11.8                                 |                                 | US170A-06-BB-016<br>US170A-06-R-047 |                 |
|  |                     |                 |             | 6.69"          | 9.09"          | 7.52"          | QL60   | 48.5            |                                      |                                 |                                     |                 |
|  |                     |                 |             | SD6            | 51.5           |                |        |                 |                                      |                                 |                                     |                 |
|  |                     |                 | Normal      | 170            | 231            | 191            | DHD360 | 49.0            | 11.9                                 |                                 |                                     | UN170A-06-R-392 |
|  |                     |                 |             | 6.69"          | 9.09"          | 7.52"          | QL60   | 48.5            |                                      |                                 |                                     |                 |
|  |                     |                 |             | SD6            | 51.5           |                |        |                 |                                      |                                 |                                     |                 |
|  |                     | 170W            | Multi use   | 170            | 227            | 191            | DHD360 | 49.0            | 11.9                                 | 170A Pilot bit                  | UM170W-06-R-289                     |                 |
|  |                     |                 |             | 6.69"          | 8.94"          | 7.52"          | QL60   | 48.5            |                                      |                                 |                                     |                 |
|  |                     |                 |             | SD6            | 51.5           |                |        |                 |                                      |                                 |                                     |                 |
|  |                     | 10.3<br>(0.41") | 170B        | Single pass    | 170            | 231            | 191    | DHD360          | 49.0                                 | 11.9                            | 170A Pilot bit<br>170A Ring bit     | US170B-06-R-265 |
|  |                     |                 |             |                | 6.69"          | 9.09"          | 7.52"  | QL60            | 48.5                                 |                                 |                                     |                 |
|  |                     |                 |             |                | SD6            | 51.5           |        |                 |                                      |                                 |                                     |                 |
|  | 10.0<br>(0.39")     | 170D            | Single pass | 170            | 231            | 191            | DHD360 | 49.0            | 12.3                                 | 170A Pilot bit<br>170A Ring bit | US170D-06-R-393                     |                 |
|  |                     |                 |             | 6.69"          | 9.09"          | 7.52"          | QL60   | 48.5            |                                      |                                 |                                     |                 |
|  |                     |                 |             | SD6            | 51.5           |                |        |                 |                                      |                                 |                                     |                 |
|  |                     | Multi use       | 170         | 227            | 191            | DHD360         | 49.0   | 12.3            | 170A Pilot bit                       | UM170X-06-R-394                 |                                     |                 |
|  |                     |                 | 6.69"       | 8.94"          | 7.52"          | QL60           | 48.5   |                 |                                      |                                 |                                     |                 |
|  |                     |                 | SD6         | 51.5           |                |                |        |                 |                                      |                                 |                                     |                 |
|  | 6.5<br>(0.26")      | 178A            | Normal      | 178            | 234            | 201            | DHD360 | 51.0            | 12.4                                 |                                 | UN178A-06-R-395                     |                 |
|  |                     |                 |             | 7.01"          | 9.21"          | 7.91"          | QL60   | 50.5            |                                      |                                 |                                     |                 |
|  |                     |                 |             | SD6            | 53.5           |                |        |                 |                                      |                                 |                                     |                 |
|  | 5.0<br>(0.20")      | 182A            | Normal      | 182            | 234            | 207            | DHD360 | 54.5            | 11.4                                 |                                 | UN182A-06-R-354                     |                 |
|  |                     |                 |             | 7.17"          | 9.21"          | 8.15"          | QL60   | 54.0            |                                      |                                 |                                     |                 |
|  |                     |                 |             | SD6            | 57.0           |                |        |                 |                                      |                                 |                                     |                 |
| 4.8<br>(0.19")                         | 187A                | Normal          | 187         | 234            | 207.5          | DHD360         | 55.5   | 9.9             |                                      | UN187A-06-R-332                 |                                     |                 |
|  |                     |                 | 7.36"       | 9.21"          | 8.17"          | QL60           | 55.0   |                 |                                      |                                 |                                     |                 |
|  |                     |                 | SD6         | 58.0           |                |                |        |                 |                                      |                                 |                                     |                 |
|  | 187W                | Multi use       | 187         | 234            | 207.5          | DHD360         | 55.5   | 9.5             |                                      | 187A Pilot bit                  | UM187W-06-R-333                     |                 |
|  |                     |                 | 7.36"       | 9.21"          | 8.17"          | QL60           | 55.0   |                 |                                      |                                 |                                     |                 |
|  |                     |                 | SD6         | 58.0           |                |                |        |                 |                                      |                                 |                                     |                 |

To be continued

# DIMENSIONS

## Standard Type ULTRA MAXBIT / DTH

Unit: mm (Upper)  
inch (Bottom)

| Casing Pipe                            |                     | Type        | Ring Bit    |                |                | Pilot Bit      |        |             | Ring Set<br>(Ring Bit & Casing Shoe) | Compatible Part | System Part Number |                 |
|--|---------------------|-------------|-------------|----------------|----------------|----------------|--------|-------------|--------------------------------------|-----------------|--------------------|-----------------|
| Outer Dia.                             | Wall Max. Thickness |             | Model       | Inner Dia.     | Outer Dia.     | Outer Dia.     | Hammer | Weight (kg) |                                      |                 |                    | Weight (kg)     |
| D <sub>2</sub>                         | t                   |             |             | D <sub>4</sub> | D <sub>1</sub> | D <sub>3</sub> |        |             |                                      |                 |                    |                 |
| <b>CASING PIPE ø241.8mm (9 33/64")</b> |                     |             |             |                |                |                |        |             |                                      |                 |                    |                 |
| 241.8<br>(9 33/64")                    | 8.0<br>(0.31")      | 200A        | Single pass | 200            | 257            | 223.5          | DHD360 | 64.5        | 12.8                                 |                 | US200A-06-R-396    |                 |
|  |                     |             |             | 7.87"          | 10.12"         | 8.80"          | QL60   | 64.0        |                                      |                 |                    |                 |
|  |                     |             |             | 200            | 257            | 223.5          | SD6    | 67.0        |                                      |                 |                    |                 |
|  |                     |             |             | 7.87"          | 10.12"         | 8.80"          | DHD380 | 76.5        |                                      |                 |                    |                 |
|  |                     | 200A        | Normal      | 200            | 257            | 223.5          | QL80   | 76.1        |                                      | 13.0            |                    | UN200A-06-R-397 |
|  |                     |             |             | 7.87"          | 10.12"         | 8.80"          | SD6    | 67.0        |                                      |                 |                    |                 |
|  |                     |             |             | 200            | 257            | 223.5          | DHD380 | 76.5        |                                      |                 |                    |                 |
|  |                     |             |             | 7.87"          | 10.12"         | 8.80"          | QL80   | 76.1        |                                      |                 |                    |                 |
|  | 6.2<br>(0.24")      | 200W        | Multi use   | 200            | 257            | 223.5          | SD8    | 69.7        | 13.5                                 | 200A Pilot bit  | UM200W-06-R-398    |                 |
|  |                     |             |             | 7.87"          | 10.12"         | 8.80"          | QL60   | 64.0        |                                      |                 |                    |                 |
|  |                     |             |             | 200            | 257            | 223.5          | SD6    | 67.0        |                                      |                 |                    |                 |
|  |                     |             |             | 7.87"          | 10.12"         | 8.80"          | DHD380 | 76.5        |                                      |                 |                    |                 |
|  |                     | 200B        | Normal      | 200            | 257            | 223.5          | QL80   | 76.1        |                                      | 13.3            | 200A Pilot bit     | UN200B-06-R-400 |
|  |                     |             |             | 7.87"          | 10.12"         | 8.80"          | SD8    | 69.7        |                                      |                 |                    |                 |
|  |                     |             |             | 200            | 257            | 223.5          | DHD380 | 76.5        |                                      |                 |                    |                 |
|  |                     |             |             | 7.87"          | 10.12"         | 8.80"          | QL80   | 76.1        |                                      |                 |                    |                 |
| <b>CASING PIPE ø244.0mm (9 39/64")</b> |                     |             |             |                |                |                |        |             |                                      |                 |                    |                 |
| 244.0<br>(9 39/64")                    | 10.0<br>(0.39")     | 194A        | Single pass | 194            | 257            | 221            | DHD360 | 59.0        | 13.3                                 |                 | US194A-06-R-182    |                 |
|  |                     |             |             | 7.64"          | 10.12"         | 8.70"          | QL60   | 58.5        |                                      |                 |                    |                 |
|  |                     |             |             |                |                |                | SD6    | 61.5        |                                      |                 |                    |                 |
| <b>CASING PIPE ø244.5mm (9 5/8")</b>   |                     |             |             |                |                |                |        |             |                                      |                 |                    |                 |
| 244.5<br>(9 5/8")                      | 13.8<br>(0.54")     | 190C        | Single pass | 190            | 257            | 214            | DHD380 | 71.2        | 14.5                                 |                 | US190C-08-R-319    |                 |
|  |                     |             |             | 7.48"          | 10.12"         | 8.43"          | QL80   | 70.8        |                                      |                 |                    |                 |
|  |                     |             |             | 190            | 257            | 214            | SD8    | 64.4        |                                      |                 |                    |                 |
|  |                     |             |             | 7.48"          | 10.12"         | 8.43"          | DHD360 | 58.0        |                                      |                 |                    |                 |
|  |                     | 190C        | Normal      | 190            | 257            | 214            | QL60   | 57.5        |                                      | 14.6            |                    | UN190C-08-R-320 |
|  |                     |             |             | 7.48"          | 10.12"         | 8.43"          | SD8    | 64.4        |                                      |                 |                    |                 |
|  |                     |             |             | 190            | 257            | 214            | DHD360 | 58.0        |                                      |                 |                    |                 |
|  |                     |             |             | 7.48"          | 10.12"         | 8.43"          | QL60   | 57.5        |                                      |                 |                    |                 |
|  |                     | 190W        | Multi use   | 190            | 253            | 214            | SD6    | 60.5        |                                      | 12.8            | 190C Pilot bit     | UM190W-08-R-321 |
|  |                     |             |             | 7.48"          | 9.96"          | 8.43"          | DHD380 | 71.2        |                                      |                 |                    |                 |
|  |                     |             |             | 190            | 253            | 214            | QL80   | 70.8        |                                      |                 |                    |                 |
|  |                     |             |             | 7.48"          | 9.96"          | 8.43"          | SD8    | 64.4        |                                      |                 |                    |                 |
|  | 12.7<br>(0.50")     | 190D        | Single pass | 190            | 257            | 214            | QL60   | 57.5        | 14.8                                 | 190C Pilot bit  | US190D-08-R-402    |                 |
|  |                     |             |             | 7.48"          | 10.12"         | 8.43"          | SD8    | 64.4        |                                      |                 |                    |                 |
|  |                     |             |             | 190            | 257            | 214            | DHD360 | 58.0        |                                      |                 |                    |                 |
|  |                     |             |             | 7.48"          | 10.12"         | 8.43"          | QL60   | 57.5        |                                      |                 |                    |                 |
|  |                     | 190D        | Normal      | 190            | 257            | 214            | SD6    | 60.5        |                                      | 14.9            | 190C Pilot bit     | UN190D-08-R-404 |
|  |                     |             |             | 7.48"          | 10.12"         | 8.43"          | DHD380 | 71.2        |                                      |                 |                    |                 |
|  |                     |             |             | 190            | 257            | 214            | QL80   | 70.8        |                                      |                 |                    |                 |
|  |                     |             |             | 7.48"          | 10.12"         | 8.43"          | SD8    | 64.4        |                                      |                 |                    |                 |
|  |                     | 190X        | Multi use   | 190            | 253            | 214            | DHD360 | 58.0        |                                      | 13.9            | 190C Pilot bit     | UM190D-06-R-405 |
|  |                     |             |             | 7.48"          | 9.96"          | 8.43"          | QL60   | 57.5        |                                      |                 |                    |                 |
|  |                     |             |             | 190            | 253            | 214            | SD6    | 60.5        |                                      |                 |                    |                 |
|  |                     |             |             | 7.48"          | 9.96"          | 8.43"          | DHD380 | 71.2        |                                      |                 |                    |                 |
| 6.0<br>(0.24")                         | 201A                | Single pass | 201         | 257            | 228            | QL80           | 78.5   | 13.2        |                                      | US201A-08-R-302 |                    |                 |
|  |                     |             | 7.91"       | 10.12"         | 8.98"          | DHD380         | 78.9   |             |                                      |                 |                    |                 |
|  |                     |             |             |                |                | QL80           | 78.5   |             |                                      |                 |                    |                 |
|  |                     |             |             |                |                | SD8            | 72.1   |             |                                      |                 |                    |                 |

Note 1) Normal model enables to be re-used in case of short hole drilling.

Note 2) To order, please advise the system type, casing size / hammer size and the ring bit models.

Note 3) Special types are also available according to customer's request.



# Standard Type ULTRA MAXBIT / DTH

Unit: mm (Upper)  
inch (Bottom)

| Casing Pipe                             |                     | Type        | Ring Bit    |                |                | Pilot Bit      |        |             | Ring Set<br>(Ring Bit & Casing Shoe) | Compatible Part                 | System Part Number |             |
|---|---------------------|-------------|-------------|----------------|----------------|----------------|--------|-------------|--------------------------------------|---------------------------------|--------------------|-------------|
| Outer Dia.                              | Wall Max. Thickness |             | Model       | Inner Dia.     | Outer Dia.     | Outer Dia.     | Hammer | Weight (kg) |                                      |                                 |                    |             |
| D <sub>2</sub>                          | t                   |             |             | D <sub>4</sub> | D <sub>1</sub> | D <sub>3</sub> |        |             |                                      |                                 |                    | Weight (kg) |
| <b>CASING PIPE ø254.0mm (10")</b>       |                     |             |             |                |                |                |        |             |                                      |                                 |                    |             |
| 254.0<br>(10")                          | 12.7<br>(0.50")     | 200X        | Multi use   | 200            | 262            | 226            | DHD380 | 78.3        | 15.4                                 |                                 | UM200X-08-R-408    |             |
|   |                     |             |             | 7.87"          | 10.31"         | 8.90"          | QL80   | 77.9        |                                      |                                 |                    |             |
|   |                     |             |             |                |                |                | SD8    | 71.5        |                                      |                                 |                    |             |
| <b>CASING PIPE ø267.4mm (10 17/32")</b> |                     |             |             |                |                |                |        |             |                                      |                                 |                    |             |
| 267.4<br>(10 17/32")                    | 9.3<br>(0.37")      | 223A        | Single pass | 223            | 281            | 246.5          | DHD380 | 90.9        | 15.0                                 |                                 | US223A-08-R-066    |             |
|   |                     |             |             | 8.78"          | 11.06"         | 9.70"          | QL80   | 90.5        |                                      |                                 |                    |             |
|   |                     |             |             |                |                |                |        |             | SD8                                  | 84.1                            |                    |             |
|   |                     | 223A        | Normal      | 223            | 281            | 246.5          | DHD380 | 90.9        | 15.1                                 |                                 | UN223A-08-R-067    |             |
|   |                     |             |             | 8.78"          | 11.06"         | 9.70"          | QL80   | 90.5        |                                      |                                 |                    |             |
|   |                     |             |             |                |                |                |        |             | SD8                                  | 84.1                            |                    |             |
|   | 223W                | Multi use   | 223         | 278            | 246.5          | DHD380         | 90.9   | 14.2        | 223A Pilot bit                       | UM223W-08-R-409                 |                    |             |
|   |                     |             | 8.78"       | 10.94"         | 9.70"          | QL80           | 90.5   |             |                                      |                                 |                    |             |
|   |                     |             |             |                |                |                |        | SD8         | 84.1                                 |                                 |                    |             |
|   | 7.8<br>(0.31")      | 223C        | Single pass | 223            | 281            | 246.5          | DHD380 | 90.9        | 15.3                                 | 223A Pilot bit<br>223A Ring bit | US223C-08-R-410    |             |
|   |                     |             |             | 8.78"          | 11.06"         | 9.70"          | QL80   | 90.5        |                                      |                                 |                    |             |
|   |                     |             |             |                |                |                |        |             | SD8                                  | 84.1                            |                    |             |
| 223C                                    |                     | Normal      | 223         | 281            | 246.5          | DHD380         | 90.9   | 15.4        | 223A Pilot bit<br>223A Ring bit      | UN223C-08-R-411                 |                    |             |
|   | 8.78"               |             | 11.06"      | 9.70"          | QL80           | 90.5           |        |             |                                      |                                 |                    |             |
|   |                     |             |             |                |                |                | SD8    | 84.1        |                                      |                                 |                    |             |
| 6.6<br>(0.26")                          | 223B                | Single pass | 223         | 281            | 246.5          | DHD380         | 90.9   | 15.5        | 223A Pilot bit<br>223A Ring bit      | US223B-08-R-412                 |                    |             |
|   |                     |             | 8.78"       | 11.06"         | 9.70"          | QL80           | 90.5   |             |                                      |                                 |                    |             |
|   |                     |             |             |                |                |                |        | SD8         | 84.1                                 |                                 |                    |             |
|   | 223B                | Normal      | 223         | 281            | 246.5          | DHD380         | 90.9   | 15.5        | 223A Pilot bit<br>223A Ring bit      | UN223B-08-R-251                 |                    |             |
| 8.78"                                   |                     |             | 11.06"      | 9.70"          | QL80           | 90.5           |        |             |                                      |                                 |                    |             |
|   |                     |             |             |                |                |                | SD8    | 84.1        |                                      |                                 |                    |             |
| <b>CASING PIPE ø273.0mm (10 3/4")</b>   |                     |             |             |                |                |                |        |             |                                      |                                 |                    |             |
| 273.0<br>(10 3/4")                      | 12.7<br>(0.50")     | 219A        | Single pass | 219            | 284            | 245            | DHD380 | 90.0        | 17.7                                 |                                 | US219A-08-R-050    |             |
|   |                     |             |             | 8.62"          | 11.18"         | 9.65"          | QL80   | 89.6        |                                      |                                 |                    |             |
|   |                     |             |             |                |                |                |        |             | SD8                                  | 83.2                            |                    |             |
|   |                     | 219A        | Normal      | 219            | 284            | 245            | DHD380 | 90.0        | 18.0                                 |                                 | UN219A-08-R-097    |             |
|   |                     |             |             | 8.62"          | 11.18"         | 9.65"          | QL80   | 89.6        |                                      |                                 |                    |             |
|   |                     |             |             |                |                |                |        |             | SD8                                  | 83.2                            |                    |             |
|   | 219W                | Multi use   | 219         | 281            | 245            | DHD380         | 90.0   | 16.6        | 219A Pilot bit                       | UM219W-08-R-413                 |                    |             |
|   |                     |             | 8.62"       | 11.06"         | 9.65"          | QL80           | 89.6   |             |                                      |                                 |                    |             |
|   |                     |             |             |                |                |                |        | SD8         | 83.2                                 |                                 |                    |             |
|   | 10.0<br>(0.39")     | 219B        | Single pass | 219            | 284            | 245            | DHD380 | 90.0        | 18.3                                 | 219A Pilot bit<br>219A Ring bit | US219B-08-R-414    |             |
|   |                     |             |             | 8.62"          | 11.18"         | 9.65"          | QL80   | 89.6        |                                      |                                 |                    |             |
|   |                     |             |             |                |                |                |        |             | SD8                                  | 83.2                            |                    |             |
|   |                     | 219B        | Normal      | 219            | 284            | 245            | DHD380 | 90.0        | 18.6                                 | 219A Pilot bit<br>219A Ring bit | UN219B-08-R-415    |             |
|   | 8.62"               |             |             | 11.18"         | 9.65"          | QL80           | 89.6   |             |                                      |                                 |                    |             |
|   |                     |             |             |                |                |                |        | SD8         | 83.2                                 |                                 |                    |             |
|   | 8.0<br>(0.31")      | 228A        | Normal      | 228            | 284            | 252.5          | DHD380 | 93.8        | 15.2                                 |                                 | UN228A-08-R-054    |             |
|   |                     |             |             | 8.98"          | 11.18"         | 9.94"          | QL80   | 93.4        |                                      |                                 |                    |             |
|   |                     |             |             |                |                |                |        |             | SD8                                  | 87.0                            |                    |             |
|   |                     | 232A        | Single pass | 232            | 284            | 255            | DHD380 | 97.3        | 13.6                                 |                                 | US232A-08-R-061    |             |
|   | 9.13"               |             |             | 11.18"         | 10.04"         | QL80           | 96.9   |             |                                      |                                 |                    |             |
|   |                     |             |             |                |                |                |        | SD8         | 90.5                                 |                                 |                    |             |
|   | 232A                | Normal      | 232         | 284            | 255            | DHD380         | 97.3   | 13.8        |                                      | UN232A-08-R-034                 |                    |             |
|   |                     |             | 9.13"       | 11.18"         | 10.04"         | QL80           | 96.9   |             |                                      |                                 |                    |             |
|   |                     |             |             |                |                |                |        | SD8         | 90.5                                 |                                 |                    |             |
| 9.2<br>(0.36")                          | 232C                | Normal      | 232         | 284            | 253            | DHD380         | 96.8   | 13.6        | 232A Ring bit                        | UN232C-08-R-192                 |                    |             |
|   |                     |             | 9.13"       | 11.18"         | 9.96"          | QL80           | 96.4   |             |                                      |                                 |                    |             |
|   |                     |             |             |                |                |                | SD8    | 90.0        |                                      |                                 |                    |             |
| 6.3<br>(0.25")                          | 232D                | Normal      | 232         | 284            | 253            | DHD380         | 96.8   | 14.1        | 232C Pilot bit<br>232A Ring bit      | UN232D-08-R-210                 |                    |             |
|   |                     |             | 9.13"       | 11.18"         | 9.96"          | QL80           | 96.4   |             |                                      |                                 |                    |             |
|   |                     |             |             |                |                |                |        | SD8         | 90.0                                 |                                 |                    |             |
|   | 232W                | Multi use   | 232         | 304            | 253            | DHD380         | 96.8   | 18.1        | 232C Pilot bit                       | UM232W-08-R-278                 |                    |             |
| 9.13"                                   |                     |             | 11.97"      | 9.96"          | QL80           | 96.4           |        |             |                                      |                                 |                    |             |
|   |                     |             |             |                |                |                | SD8    | 90.0        |                                      |                                 |                    |             |

To be continued 

# DIMENSIONS

## Standard Type ULTRA MAXBIT / DTH

Unit: mm (Upper)  
inch (Bottom)

| Casing Pipe                             |                        | Type        | Ring Bit    |                |                | Pilot Bit      |        |                | Ring Set<br>(Ring Bit &<br>Casing Shoe) | Compatible<br>Part | System Part<br>Number |                 |
|---|------------------------|-------------|-------------|----------------|----------------|----------------|--------|----------------|---|--------------------|-----------------------|-----------------|
| Outer<br>Dia.                           | Wall Max.<br>Thickness |             | Model       | Inner<br>Dia.  | Outer<br>Dia.  | Outer<br>Dia.  | Hammer | Weight<br>(kg) |   |                    |                       |                 |
| D <sub>2</sub>                          | t                      |             |             | D <sub>4</sub> | D <sub>1</sub> | D <sub>3</sub> |        |                |   |                    |                       | Weight<br>(kg)  |
| <b>CASING PIPE ø300.0mm (11 13/16")</b> |                        |             |             |                |                |                |        |                |   |                    |                       |                 |
| 300.0<br>(11 13/16")                    | 8.0<br>(0.31")         | 254A        | Single pass | 254            | 315            | 281            | DHD380 | 112.0          | 17.2                                    |                    | US254A-08-R-273       |                 |
|   |                        |             |             | 10.00"         | 12.40"         | 11.06"         | QL80   | 111.6          |   |                    |                       |                 |
|   |                        |             |             |                |                |                | SD8    | 105.2          |   |                    |                       |                 |
| <b>CASING PIPE ø318.5mm (12 17/32")</b> |                        |             |             |                |                |                |        |                |   |                    |                       |                 |
| 318.5<br>(12 17/32")                    | 10.3<br>(0.41")        | 270A        | Single pass | 270            | 335            | 295            | DHD380 | 121.4          | 20.0                                    |                    | US270A-08-R-418       |                 |
|   |                        |             |             | 10.63"         | 13.19"         | 11.61"         | QL80   | 121.0          |   |                    |                       |                 |
|   |                        |             |             |                |                |                | SD8    | 114.6          |   |                    |                       |                 |
|   |                        |             |             |                |                |                |        |                |   |                    |                       |                 |
|   |                        | 270A        | Normal      | 270            | 335            | 295            | DHD310 | 143.5          | 20.4                                    |                    |                       | UN270A-10-R-069 |
|   |                        |             |             | 10.63"         | 13.19"         | 11.61"         | SD10   | 139.5          |   |                    |                       |                 |
|   |                        |             |             |                |                |                |        |                |   |                    |                       |                 |
|   |                        |             |             |                |                |                |        |                |   |                    |                       |                 |
|   |                        | 270X        | Multi use   | 270            | 335            | 295            | DHD380 | 121.4          | 19.1                                    | 270A Pilot bit     |                       | UM270X-08-R420  |
|   |                        |             |             | 10.63"         | 13.19"         | 11.61"         | QL80   | 121.0          |   |                    |                       |                 |
|   |                        |             |             |                |                |                | SD8    | 114.6          |   |                    |                       |                 |
|   |                        |             |             |                |                |                |        |                |   |                    |                       |                 |
|   | 270D                   | Single pass | 270         | 335            | 295            | DHD310         | 143.5  | 20.5           | 270A Pilot bit<br>270A Ring bit         |                    | US270D-10-R-437       |                 |
|   |                        |             | 10.63"      | 13.19"         | 11.61"         | SD10           | 139.5  |                |   |                    |                       |                 |
|   |                        |             |             |                |                |                |        |                |   |                    |                       |                 |
|   |                        |             |             |                |                |                |        |                |   |                    |                       |                 |
|   | 270D                   | Normal      | 270         | 335            | 295            | DHD310         | 143.5  | 20.9           | 270A Pilot bit<br>270A Ring bit         |                    | UN270D-10-R-438       |                 |
|   |                        |             | 10.63"      | 13.19"         | 11.61"         | SD10           | 139.5  |                |   |                    |                       |                 |
|   |                        |             |             |                |                |                |        |                |   |                    |                       |                 |
|   |                        |             |             |                |                |                |        |                |   |                    |                       |                 |
|   | 270C                   | Normal      | 270         | 335            | 295            | DHD310         | 143.5  | 21.2           | 270A Pilot bit<br>270A Ring bit         |                    | UN270C-10-R-348       |                 |
|   |                        |             | 10.63"      | 13.19"         | 11.61"         | SD10           | 139.5  |                |   |                    |                       |                 |
|   |                        |             |             |                |                |                |        |                |   |                    |                       |                 |
|   |                        |             |             |                |                |                |        |                |   |                    |                       |                 |

Note 1) Normal model enables to be re-used in case of short hole drilling.

Note 2) To order, please advise the system type, casing size / hammer size and the ring bit models.

Note 3) Special types are also available according to customer's request.

# Standard Type ULTRA MAXBIT / DTH

Unit: mm (Upper)  
inch (Bottom)

| Casing Pipe                           |                         | Type      | Ring Bit    |                |                | Pilot Bit      |        |                | Ring Set<br>(Ring Bit & Casing Shoe) | Compatible Part | System Part Number |             |
|---------------------------------------|-------------------------|-----------|-------------|----------------|----------------|----------------|--------|----------------|--------------------------------------|-----------------|--------------------|-------------|
| Outer Dia.                            | Wall Max. Thickness     |           | Model       | Inner Dia.     | Outer Dia.     | Outer Dia.     | Hammer | Weight (kg)    |                                      |                 |                    | Weight (kg) |
| D <sub>2</sub>                        | t                       |           |             | D <sub>4</sub> | D <sub>1</sub> | D <sub>3</sub> |        |                |                                      |                 |                    |             |
| <b>CASING PIPE ø323.9mm (12 3/4")</b> |                         |           |             |                |                |                |        |                |                                      |                 |                    |             |
| <b>323.9<br/>(12 3/4")</b>            | <b>12.7<br/>(0.50")</b> | 273A      | Single pass | 273            | 338            | 296            | DHD380 | 123.5          | 21.2                                 |                 | US273A-08-R-051    |             |
|                                       |                         |           |             | 10.75"         | 13.31"         | 11.65"         | QL80   | 123.1          |                                      |                 |                    |             |
|                                       |                         |           |             |                |                |                | SD8    | 116.7          |                                      |                 |                    |             |
|                                       |                         | 273W      | Multi use   | 273            | 333            | 296            | DHD380 | 123.5          | 20.2                                 | 273A Pilot bit  | UM273W-08-R-215    |             |
|                                       |                         |           |             | 10.75"         | 13.11"         | 11.65"         | QL80   | 123.1          |                                      |                 |                    |             |
|                                       |                         |           |             |                |                |                | SD8    | 116.7          |                                      |                 |                    |             |
|                                       | <b>10.0<br/>(0.39")</b> | 273C      | Single pass | 273            | 338            | 298            | DHD380 | 124.5          | 21.5                                 | 273A Ring bit   | US273C-08-R439     |             |
|                                       |                         |           |             | 10.75"         | 13.31"         | 11.73"         | QL80   | 124.1          |                                      |                 |                    |             |
|                                       |                         |           |             |                |                |                | SD8    | 117.7          |                                      |                 |                    |             |
|                                       |                         | 273C      | Normal      | 273            | 338            | 298            | DHD380 | 124.5          | 21.7                                 | 273A Ring bit   | UN273C-08-R440     |             |
|                                       |                         |           |             | 10.75"         | 13.31"         | 11.73"         | QL80   | 124.1          |                                      |                 |                    |             |
|                                       |                         |           |             |                |                |                | SD8    | 117.7          |                                      |                 |                    |             |
|                                       | 273X                    | Multi use | 273         | 338            | 298            | DHD380         | 124.5  | 20.0           | 273C Pilot bit                       | UM273X-08-R-257 |                    |             |
|                                       |                         |           | 10.75"      | 13.31"         | 11.73"         | QL80           | 124.1  |                |                                      |                 |                    |             |
|                                       |                         |           |             |                |                | SD8            | 117.7  |                |                                      |                 |                    |             |
|                                       | <b>8.0<br/>(0.31")</b>  | 281A      | Single pass | 281            | 338            | 305            | DHD380 | 130.0          | 17.6                                 |                 | US281A-08-R-214    |             |
|                                       |                         |           |             | 11.06"         | 13.31"         | 12.01"         | QL80   | 129.6          |                                      |                 |                    |             |
|                                       |                         |           |             |                |                |                | SD8    | 123.2          |                                      |                 |                    |             |
|                                       |                         | 281A      | Normal      | 281            | 338            | 305            | DHD380 | 130.0          | 17.8                                 |                 | UN281A-08-R-074    |             |
|                                       |                         |           |             | 11.06"         | 13.31"         | 12.01"         | QL80   | 129.6          |                                      |                 |                    |             |
|                                       |                         |           |             |                |                |                | SD8    | 123.2          |                                      |                 |                    |             |
|                                       |                         |           |             | 281            | 338            | 305            | DHD310 | 150.0          |                                      |                 | UN281A-10-R-091    |             |
|                                       |                         |           |             | 11.06"         | 13.31"         | 12.01"         | SD10   | 146.0          |                                      |                 |                    |             |
|                                       |                         |           |             |                |                |                |        |                |                                      |                 |                    |             |
| 281                                   |                         |           |             | 338            | 305            | DHD112         | 173.0  |                |                                      | UN281A-12-R-062 |                    |             |
| 11.06"                                |                         |           |             | 13.31"         | 12.01"         | QL120          | 203.0  |                |                                      |                 |                    |             |
|                                       |                         |           |             |                |                | NUMA11/120     | 182.0  |                |                                      |                 |                    |             |
| 281W                                  |                         | Multi use | 281         | 333            | 305            | DHD380         | 130.0  | 16.3           | 281A Pilot bit                       | UM281W-08-R-216 |                    |             |
|                                       |                         |           | 11.06"      | 13.11"         | 12.01"         | QL80           | 129.6  |                |                                      |                 |                    |             |
|                                       |                         |           |             |                |                | SD8            | 123.2  |                |                                      |                 |                    |             |
|                                       |                         |           | 281         | 333            | 305            | DHD310         | 150.0  |                | 281A Pilot bit                       | UM281W-10-R-267 |                    |             |
|                                       |                         |           | 11.06"      | 13.11"         | 12.01"         | SD10           | 146.0  |                |                                      |                 |                    |             |
|                                       |                         |           |             |                |                |                |        |                |                                      |                 |                    |             |
| <b>6.4<br/>(0.25")</b>                | 281B                    | Normal    | 281         | 338            | 305            | DHD380         | 130.0  | 18.2           | 281A Pilot bit<br>281A Ring bit      | UN281B-08-R-339 |                    |             |
|                                       |                         |           | 11.06"      | 13.31"         | 12.01"         | QL80           | 129.6  |                |                                      |                 |                    |             |
|                                       |                         |           |             |                |                | SD8            | 123.2  |                |                                      |                 |                    |             |
|                                       | 281X                    | Multi use | 281         | 338            | 305            | DHD310         | 150.0  | 16.7           | 281A Pilot bit<br>281A Ring bit      | UN281B-10-R-441 |                    |             |
|                                       |                         |           | 11.06"      | 13.31"         | 12.01"         | SD10           | 146.0  |                |                                      |                 |                    |             |
|                                       |                         |           |             |                |                |                |        |                |                                      |                 |                    |             |
| 281X                                  | Multi use               | 281       | 333         | 305            | DHD380         | 130.0          | 16.7   | 281A Pilot bit | UM281X-08-R-340                      |                 |                    |             |
|                                       |                         | 11.06"    | 13.11"      | 12.01"         | QL80           | 129.6          |        |                |                                      |                 |                    |             |
|                                       |                         | 281       | 333         | 305            | DHD310         | 150.0          |        | 281A Pilot bit | UM281X-10-R442                       |                 |                    |             |
|                                       |                         | 11.06"    | 13.11"      | 12.01"         | SD10           | 146.0          |        |                |                                      |                 |                    |             |

To be continued

# DIMENSIONS

## Standard Type ULTRA MAXBIT / DTH

Unit: mm (Upper)  
inch (Bottom)

| Casing Pipe                       |                         | Type   | Ring Bit    |                |                | Pilot Bit      |            |                 | Ring Set<br>(Ring Bit & Casing Shoe) | Compatible Part                 | System Part Number |                 |
|-----------------------------------|-------------------------|--------|-------------|----------------|----------------|----------------|------------|-----------------|--------------------------------------|---------------------------------|--------------------|-----------------|
| Outer Dia.                        | Wall Max. Thickness     |        | Model       | Inner Dia.     | Outer Dia.     | Outer Dia.     | Hammer     | Weight (kg)     |                                      |                                 |                    | Weight (kg)     |
| D <sub>2</sub>                    | t                       |        |             | D <sub>4</sub> | D <sub>1</sub> | D <sub>3</sub> |            |                 |                                      |                                 |                    |                 |
| <b>CASING PIPE ø355.6mm (14")</b> |                         |        |             |                |                |                |            |                 |                                      |                                 |                    |                 |
| <b>355.6<br/>(14")</b>            | <b>12.7<br/>(0.50")</b> | 300A   | Normal      | 300            | 370            | 327            | DHD112     | 189.5           | 25.3                                 |                                 | UN300A-12-R-055    |                 |
|                                   |                         |        |             | 11.81"         | 14.57"         |                | 12.87"     | QL120           |                                      |                                 |                    | 219.5           |
|                                   |                         |        |             |                |                |                |            | NUMA11/120      |                                      |                                 |                    | 198.5           |
|                                   |                         |        |             |                |                |                |            | NUMA125         |                                      |                                 |                    | 210.5           |
|                                   |                         |        |             |                |                |                |            | SD12            |                                      |                                 |                    | 189.5           |
|                                   |                         |        |             | 300            | 370            |                | 327        | DH310           |                                      |                                 |                    | 167.5           |
|                                   |                         | 11.81" | 14.57"      | 12.87"         | SD10           | 163.5          |            |                 |                                      |                                 |                    |                 |
|                                   |                         |        |             |                |                |                |            |                 |                                      |                                 |                    |                 |
|                                   |                         |        |             |                |                |                |            |                 |                                      |                                 |                    |                 |
|                                   |                         |        |             |                |                |                |            |                 |                                      |                                 |                    |                 |
|                                   |                         | 300W   | Multi use   | 300            | 370            | 327            | DHD112     | 189.5           |                                      | 24.2                            | 300A Pilot bit     | UM300W-12-R-443 |
|                                   |                         |        |             | 11.81"         | 14.57"         |                | 12.87"     | QL120           |                                      |                                 |                    |                 |
|                                   | NUMA11/120              |        |             |                |                |                |            | 198.5           |                                      |                                 |                    |                 |
|                                   | NUMA125                 |        |             |                |                |                |            | 210.5           |                                      |                                 |                    |                 |
|                                   | SD12                    |        |             |                |                |                |            | 189.5           |                                      |                                 |                    |                 |
|                                   | 300                     |        |             | 370            | 327            |                | DH310      | 167.5           | 300A Pilot bit                       |                                 |                    |                 |
|                                   | 11.81"                  | 14.57" | 12.87"      | SD10           | 163.5          |                |            |                 |                                      |                                 |                    |                 |
|                                   |                         |        |             |                |                |                |            |                 |                                      |                                 |                    |                 |
|                                   |                         |        |             |                |                |                |            |                 |                                      |                                 |                    |                 |
|                                   |                         |        |             |                |                |                |            |                 |                                      |                                 |                    |                 |
|                                   | <b>9.5<br/>(0.37")</b>  | 300B   | Single pass | 300            | 370            | 333.5          | DH310      | 169.0           |                                      |                                 | 25.3               |                 |
|                                   |                         |        |             | 11.81"         | 14.57"         |                | 13.13"     | SD10            | 169.0                                |                                 |                    |                 |
|                                   |                         | 300B   | Normal      |                |                | 300            |            | 370             | 333.5                                | DHD112                          | 191                | 25.6            |
|                                   |                         |        |             | 11.81"         | 14.57"         | 13.13"         | QL120      | 221             |                                      |                                 |                    |                 |
| NUMA11/120                        |                         |        |             |                |                |                | 200        |                 |                                      |                                 |                    |                 |
| NUMA125                           |                         |        |             |                |                |                | 222        |                 |                                      |                                 |                    |                 |
| SD12                              |                         |        |             |                |                |                | 191        |                 |                                      |                                 |                    |                 |
| 300                               |                         |        |             | 370            | 333.5          | DH310          | 169        | UN300B-10-R-446 |                                      |                                 |                    |                 |
| 11.81"                            |                         | 14.57" | 13.13"      | SD10           | 165            |                |            |                 |                                      |                                 |                    |                 |
|                                   |                         |        |             |                |                |                |            |                 |                                      |                                 |                    |                 |
|                                   |                         |        |             |                |                |                |            |                 |                                      |                                 |                    |                 |
|                                   |                         |        |             |                |                |                |            |                 |                                      |                                 |                    |                 |
| 300X                              | Multi use               | 300    | 370         | 333.5          | DHD112         | 191            | 24.4       |                 | 300B Pilot bit                       | UM300X-12-R-447                 |                    |                 |
|                                   |                         | 11.81" | 14.57"      |                | 13.13"         | QL120          |            | 221             |                                      |                                 |                    |                 |
|                                   |                         |        |             |                |                | NUMA11/120     |            | 200             |                                      |                                 |                    |                 |
|                                   |                         |        |             |                |                | NUMA125        |            | 222             |                                      |                                 |                    |                 |
|                                   |                         |        |             |                |                | SD12           |            | 191             |                                      |                                 |                    |                 |
|                                   |                         | 300    | 370         |                | 333.5          | DH310          |            | 169             |                                      |                                 | 300B Pilot bit     | UM300X-10-R-448 |
| 11.81"                            | 14.57"                  | 13.13" | SD10        | 165            |                |                |            |                 |                                      |                                 |                    |                 |
|                                   |                         |        |             |                |                |                |            |                 |                                      |                                 |                    |                 |
|                                   |                         |        |             |                |                |                |            |                 |                                      |                                 |                    |                 |
|                                   |                         |        |             |                |                |                |            |                 |                                      |                                 |                    |                 |
| <b>7.9<br/>(0.31")</b>            | 300C                    | Normal | 300         | 370            | 333.5          | DHD112         |            | 191             | 25.6                                 | 300B Pilot bit<br>300B Ring bit |                    |                 |
|                                   |                         |        | 11.81"      | 14.57"         |                | 13.13"         |            | QL120           |                                      |                                 | 221                |                 |
|                                   |                         |        |             |                |                |                | NUMA11/120 | 200             |                                      |                                 |                    |                 |
|                                   |                         |        | 11.81"      | 14.57"         |                | 13.13"         | NUMA125    | 222             |                                      |                                 |                    |                 |
| SD12                              | 191                     |        |             |                |                |                |            |                 |                                      |                                 |                    |                 |
| <b>6.3<br/>(0.25")</b>            | 300D                    | Normal | 300         | 370            | 333.5          | DHD112         | 191        | 26.4            |                                      | 300B Pilot bit<br>300B Ring bit | UN300D-12-R-357    |                 |
|                                   |                         |        | 11.81"      | 14.57"         |                | 13.13"         | QL120      |                 |                                      |                                 |                    | 221             |
|                                   |                         |        |             |                |                |                | NUMA11/120 |                 |                                      |                                 |                    | 200             |
|                                   |                         |        | 11.81"      | 14.57"         |                | 13.13"         | NUMA125    |                 | 222                                  |                                 |                    |                 |
| SD12                              | 191                     |        |             |                |                |                |            |                 |                                      |                                 |                    |                 |

Note 1) Normal model enables to be re-used in case of short hole drilling.

Note 2) To order, please advise the system type, casing size / hammer size and the ring bit models.

Note 3) Special types are also available according to customer's request.

# Standard Type ULTRA MAXBIT / DTH

Unit: mm (Upper)  
inch (Bottom)

| Casing Pipe                       |                     | Type        | Ring Bit    |                |                | Pilot Bit      |            |             | Ring Set<br>(Ring Bit & Casing Shoe) | Compatible Part | System Part Number |     |
|-----------------------------------|---------------------|-------------|-------------|----------------|----------------|----------------|------------|-------------|--------------------------------------|-----------------|--------------------|-----|
| Outer Dia.                        | Wall Max. Thickness |             | Model       | Inner Dia.     | Outer Dia.     | Outer Dia.     | Hammer     | Weight (kg) |                                      |                 |                    |     |
| D <sub>2</sub>                    | t                   |             |             | D <sub>4</sub> | D <sub>1</sub> | D <sub>3</sub> |            |             |                                      |                 |                    |     |
| <b>CASING PIPE ø406.4mm (16")</b> |                     |             |             |                |                |                |            |             |                                      |                 |                    |     |
| 406.4<br>(16")                    | 12.7<br>(0.50")     | 354A        | Single pass | 354            | 420            | 378            | DHD112     | 233         | 27.0                                 |                 | US354A-12-R-105    |     |
|                                   |                     |             |             | 13.94"         | 16.54"         |                | 14.88"     | QL120       |                                      |                 |                    | 263 |
|                                   |                     |             |             |                |                |                |            | NUMA11/120  |                                      |                 |                    | 242 |
|                                   |                     |             |             |                | NUMA125        | 264            |            |             |                                      |                 |                    |     |
|                                   |                     |             |             |                | SD12           | 233            |            |             |                                      |                 |                    |     |
|                                   |                     |             |             |                |                |                |            |             |                                      |                 |                    |     |
|                                   |                     | 354X        | Multi use   | 354            | 420            | 378            | DHD112     | 233         | 26.0                                 | 354A Pilot bit  | UM354X-12-R-263    |     |
|                                   | 13.94"              |             |             | 16.54"         | 14.88"         |                | QL120      | 263         |                                      |                 |                    |     |
|                                   |                     |             |             |                |                |                | NUMA11/120 | 242         |                                      |                 |                    |     |
|                                   |                     |             |             |                |                |                | NUMA125    | 264         |                                      |                 |                    |     |
|                                   |                     |             |             |                |                |                | SD12       | 233         |                                      |                 |                    |     |
|                                   |                     |             |             |                |                |                |            |             |                                      |                 |                    |     |
| 10.0<br>(0.39")                   | 354B                | Single pass | 354         | 420            | 378            | DHD112         | 233        | 27.9        | 354A Pilot bit<br>354A Ring bit      | US354B-12-R-294 |                    |     |
|                                   |                     |             | 13.94"      | 16.54"         |                | 14.88"         | QL120      |             |                                      |                 | 263                |     |
|                                   |                     |             |             |                |                |                | NUMA11/120 |             |                                      |                 | 242                |     |
|                                   |                     |             |             |                |                |                | NUMA125    |             |                                      |                 | 264                |     |
|                                   |                     |             |             |                |                |                | SD12       |             |                                      |                 | 233                |     |
|                                   |                     |             |             |                |                |                |            |             |                                      |                 |                    |     |
| <b>CASING PIPE ø457.2mm (18")</b> |                     |             |             |                |                |                |            |             |                                      |                 |                    |     |
| 457.2<br>(18")                    | 12.7<br>(0.50")     | 393A        | Single pass | 393            | 472            | 426            | DHD112     | 274         | 37.8                                 |                 | US393A-12-R-128    |     |
|                                   |                     |             |             | 15.47"         | 18.58"         |                | 16.77"     | QL120       |                                      |                 |                    | 304 |
|                                   |                     |             |             |                |                |                |            | NUMA11/120  |                                      |                 |                    | 283 |
|                                   |                     |             |             |                | NUMA125        | 305            |            |             |                                      |                 |                    |     |
|                                   |                     |             |             |                | SD12           | 274            |            |             |                                      |                 |                    |     |
|                                   |                     |             |             |                |                |                |            |             |                                      |                 |                    |     |
|                                   |                     | 393W        | Multi use   | 393            | 472            | 426            | DHD112     | 274         | 36.5                                 | 393A Pilot bit  | UM393W-12-R-457    |     |
|                                   | 15.47"              |             |             | 18.58"         | 16.77"         |                | QL120      | 304         |                                      |                 |                    |     |
|                                   |                     |             |             |                |                |                | NUMA11/120 | 283         |                                      |                 |                    |     |
|                                   |                     |             |             |                |                |                | NUMA125    | 305         |                                      |                 |                    |     |
|                                   |                     |             |             |                |                |                | SD12       | 274         |                                      |                 |                    |     |
|                                   |                     |             |             |                |                |                |            |             |                                      |                 |                    |     |
| 10.0<br>(0.39")                   | 393B                | Single pass | 393         | 472            | 426            | DHD112         | 274        | 38.8        | 393A Pilot bit<br>393A Ring bit      | US393B-12-R-458 |                    |     |
|                                   |                     |             | 15.47"      | 18.58"         |                | 16.77"         | QL120      |             |                                      |                 | 304                |     |
|                                   |                     |             |             |                |                |                | NUMA11/120 |             |                                      |                 | 283                |     |
|                                   |                     |             |             |                |                |                | NUMA125    |             |                                      |                 | 305                |     |
|                                   |                     |             |             |                |                |                | SD12       |             |                                      |                 | 274                |     |
|                                   |                     |             |             |                |                |                |            |             |                                      |                 |                    |     |

To be continued 

# DIMENSIONS

## Standard Type ULTRA MAXBIT / DTH

Unit: mm (Upper)  
inch (Bottom)

| Casing Pipe                       |                        | Type            | Ring Bit    |                |                | Pilot Bit      |            |                | Ring Set<br>(Ring Bit &<br>Casing Shoe) | Compatible<br>Part              | System Part<br>Number           |                 |
|-----------------------------------|------------------------|-----------------|-------------|----------------|----------------|----------------|------------|----------------|---|---------------------------------|---------------------------------|-----------------|
| Outer<br>Dia.                     | Wall Max.<br>Thickness |                 | Model       | Inner<br>Dia.  | Outer<br>Dia.  | Outer<br>Dia.  | Hammer     | Weight<br>(kg) |   |                                 |                                 | Weight<br>(kg)  |
| D <sub>2</sub>                    | t                      |                 |             | D <sub>4</sub> | D <sub>1</sub> | D <sub>3</sub> |            |                |   |                                 |                                 |                 |
| <b>CASING PIPE ø508.0mm (20")</b> |                        |                 |             |                |                |                |            |                |   |                                 |                                 |                 |
| 508.0<br>(20")                    | 16.0<br>(0.63")        | 445B            | Single pass | 445            | 521            | 473            | DHD112     | 356            | 41.0                                    |                                 | US445B-12-R-153<br>*OVER SIZE   |                 |
|                                   |                        |                 |             | 17.52"         | 20.51"         | 18.62"         | QL120      | 386            |   |                                 |                                 |                 |
|                                   |                        |                 |             |                |                |                | NUMA11/120 | 365            |   |                                 |                                 |                 |
|                                   |                        |                 |             |                |                |                | NUMA125    | 387            |   |                                 |                                 |                 |
|                                   |                        |                 |             |                |                |                | SD12       | 356            |   |                                 |                                 |                 |
|                                   |                        |                 |             |                |                |                |            |                |   |                                 |                                 |                 |
|                                   |                        |                 |             |                | 445            | 521            | 473        | DHD112S        |   | 423                             | 445B Pilot bit                  | US445B-15-R-112 |
|                                   |                        | 17.52"          | 20.51"      | 18.62"         | NUMA120S       | 447            |            |                |   |                                 |                                 |                 |
|                                   |                        |                 |             |                | SD15S          | 459            |            |                |   |                                 |                                 |                 |
|                                   |                        |                 |             |                | QL200          | 445            |            |                |   |                                 |                                 |                 |
|                                   |                        |                 |             |                | NUMA180        | 506            |            |                |   |                                 |                                 |                 |
|                                   |                        |                 |             |                | SD18           | 544            |            |                |   |                                 |                                 |                 |
|                                   |                        | 445W            | Multi use   | 445            | 521            | 473            | DHD112     | 356            | 39.1                                    | 445B Pilot bit                  | UM445W-12-R-451<br>*OVER SIZE   |                 |
|                                   | 17.52"                 |                 |             | 20.51"         | 18.62"         | QL120          | 386        |                |   |                                 |                                 |                 |
|                                   |                        |                 |             |                |                | NUMA11/120     | 365        |                |   |                                 |                                 |                 |
|                                   |                        |                 |             |                |                | NUMA125        | 387        |                |   |                                 |                                 |                 |
|                                   |                        |                 |             |                |                | SD12           | 356        |                |   |                                 |                                 |                 |
|                                   |                        |                 |             |                |                |                |            |                |   |                                 |                                 |                 |
|                                   |                        |                 |             | 445            | 521            | 473            | DHD112S    | 423            |   | 445B Pilot bit                  | UM445W-15-R-452                 |                 |
|                                   | 17.52"                 | 20.51"          | 18.62"      | NUMA120S       | 447            |                |            |                |   |                                 |                                 |                 |
|                                   |                        |                 |             | SD15S          | 459            |                |            |                |   |                                 |                                 |                 |
|                                   |                        |                 |             | QL200          | 445            |                |            |                |   |                                 |                                 |                 |
|                                   |                        |                 |             | NUMA180        | 506            |                |            |                |   |                                 |                                 |                 |
|                                   |                        |                 |             | SD18           | 544            |                |            |                |   |                                 |                                 |                 |
|                                   | 445D                   | Single pass     | 445         | 521            | 473            | DHD112S        | 423        | 41.8           | 445B Pilot bit<br>445B Ring bit         | US445D-15-R-241                 |                                 |                 |
| 17.52"                            |                        |                 | 20.51"      | 18.62"         | NUMA120S       | 447            |            |                |   |                                 |                                 |                 |
|                                   |                        |                 |             |                | SD15S          | 459            |            |                |   |                                 |                                 |                 |
|                                   |                        |                 |             |                | QL200          | 445            |            |                |   |                                 |                                 |                 |
|                                   |                        |                 |             |                | NUMA180        | 506            |            |                |   |                                 |                                 |                 |
|                                   |                        |                 |             |                | SD18           | 544            |            |                |   |                                 |                                 |                 |
|                                   | 445X                   | Multi use       | 445         | 521            | 473            | DHD112S        | 423        |                | 40.1                                    | 445B Pilot bit                  | UM445X-15-R-454                 |                 |
| 17.52"                            |                        |                 | 20.51"      | 18.62"         | NUMA120S       | 447            |            |                |   |                                 |                                 |                 |
|                                   |                        |                 |             |                | SD15S          | 459            |            |                |   |                                 |                                 |                 |
|                                   |                        |                 |             |                | QL200          | 445            |            |                |   |                                 |                                 |                 |
|                                   |                        |                 |             |                | NUMA180        | 506            |            |                |   |                                 |                                 |                 |
|                                   |                        |                 |             |                | SD18           | 544            |            |                |   |                                 |                                 |                 |
|                                   | 445A                   | Single pass     | 445         | 521            | 473            | DHD112         | 356        | 42.2           |   | 445B Pilot bit<br>445B Ring bit | US445A-12-R-290<br>*OVER SIZE   |                 |
| 17.52"                            |                        |                 | 20.51"      | 18.62"         | QL120          | 386            |            |                |   |                                 |                                 |                 |
|                                   |                        |                 |             |                | NUMA11/120     | 365            |            |                |   |                                 |                                 |                 |
|                                   |                        |                 |             |                | NUMA125        | 387            |            |                |   |                                 |                                 |                 |
|                                   |                        |                 |             |                | SD12           | 356            |            |                |   |                                 |                                 |                 |
|                                   |                        |                 |             |                |                |                |            |                |   |                                 |                                 |                 |
|                                   |                        |                 | 445         | 521            | 473            | DHD112S        | 423        |                | 445B Pilot bit<br>445B Ring bit         | US445A-15-R-111                 |                                 |                 |
| 17.52"                            | 20.51"                 | 18.62"          | NUMA120S    | 447            |                |                |            |                |   |                                 |                                 |                 |
|                                   |                        |                 | SD15S       | 459            |                |                |            |                |   |                                 |                                 |                 |
|                                   |                        |                 | QL200       | 445            |                |                |            |                |   |                                 |                                 |                 |
|                                   |                        |                 | NUMA180     | 506            |                |                |            |                |   |                                 |                                 |                 |
|                                   |                        |                 | SD18        | 544            |                |                |            |                |   |                                 |                                 |                 |
|                                   | 10.0<br>(0.39")        | 445C            | Single pass | 445            | 521            | 473            | QL200      | 445            | 43.6                                    | 445B Pilot bit<br>445B Ring bit | US445C-18-R-150                 |                 |
| 17.52"                            |                        |                 |             | 20.51"         | 18.62"         | NUMA180        | 506        |                |   |                                 |                                 |                 |
|                                   |                        |                 |             |                |                |                | SD18       | 544            |   |                                 |                                 |                 |
| <b>CASING PIPE ø558.8mm (22")</b> |                        |                 |             |                |                |                |            |                |   |                                 |                                 |                 |
| 558.8<br>(22")                    | 14.0<br>(0.55")        | 494A            | Single pass | 494            | 573            | 523            | QL200      | 509            | 47.2                                    |                                 | US494A-18-R-162                 |                 |
|                                   |                        |                 |             | 19.45"         | 22.56"         | 20.59"         | NUMA180    | 570            |   |                                 |                                 |                 |
|                                   |                        |                 |             |                | SD18           | 608            |            |                |   |                                 |                                 |                 |
|                                   |                        |                 |             |                |                |                |            |                |   |                                 |                                 |                 |
|                                   |                        | 494W            | Multi use   | 494            | 573            | 523            | QL200      | 509            | 45.1                                    | 494A Pilot bit                  | UM494W-18-R-449                 |                 |
|                                   | 19.45"                 |                 |             | 22.56"         | 20.59"         | NUMA180        | 570        |                |   |                                 |                                 |                 |
|                                   |                        |                 |             | SD18           | 608            |                |            |                |   |                                 |                                 |                 |
|                                   |                        |                 |             |                |                |                |            |                |   |                                 |                                 |                 |
|                                   |                        | 12.7<br>(0.50") | 494B        | Single pass    | 494            | 573            | 523        | QL200          | 509                                     | 47.9                            | 494A Pilot bit<br>494A Ring bit | US494B-18-R-436 |
|                                   | 19.45"                 |                 |             |                | 22.56"         | 20.59"         | NUMA180    | 570            |   |                                 |                                 |                 |
|                                   |                        |                 |             | SD18           | 608            |                |            |                |   |                                 |                                 |                 |
|                                   |                        |                 |             |                |                |                |            |                |   |                                 |                                 |                 |
|                                   | 494X                   | Multi use       | 494         | 573            | 523            | QL200          | 509        | 45.7           | 494A Pilot bit                          | UM494X-18-R-450                 |                                 |                 |
| 19.45"                            |                        |                 | 22.56"      | 20.59"         | NUMA180        | 570            |            |                |   |                                 |                                 |                 |
|                                   |                        |                 | SD18        | 608            |                |                |            |                |   |                                 |                                 |                 |
|                                   |                        |                 |             |                |                |                |            |                |   |                                 |                                 |                 |

\*Over size : No shank breakage warranty.

Note 1) Normal model enables to be re-used in case of short hole drilling.

Note 2) To order, please advise the system type, casing size / hammer size and the ring bit models.

Note 3) Special types are also available according to customer's request.

# Standard Type ULTRA MAXBIT / DTH

Unit: mm (Upper)  
inch (Bottom)

| Casing Pipe  |                     | Type        | Ring Bit    |                |                | Pilot Bit      |         |             | Ring Set<br>(Ring Bit & Casing Shoe) | Compatible Part               | System Part Number              |                               |                               |
|--|---------------------|-------------|-------------|----------------|----------------|----------------|---------|-------------|--------------------------------------|-------------------------------|---------------------------------|-------------------------------|-------------------------------|
| Outer Dia.   | Wall Max. Thickness |             | Model       | Inner Dia.     | Outer Dia.     | Outer Dia.     | Hammer  | Weight (kg) |                                      |                               |                                 | Weight (kg)                   |                               |
| D <sub>2</sub>   | t                   |             |             | D <sub>4</sub> | D <sub>1</sub> | D <sub>3</sub> |         |             |                                      |                               |                                 |                               |                               |
| <b>CASING PIPE ø609.6mm (24")</b>  |                     |             |             |                |                |                |         |             |                                      |                               |                                 |                               |                               |
| 609.6<br>(24")   | 16.0<br>(0.63")     | 545A        | Single pass | 545            | 625            | 574            | QL200   | 590         | 51.4                                 |                               | US545A-18-R-129                 |                               |                               |
|  |                     |             |             | 21.46"         | 24.61"         | 22.60"         | NUMA180 | 651         |                                      |                               |                                 |                               |                               |
|  |                     | SD18        | 689         |                |                |                |         |             |                                      |                               |                                 |                               |                               |
|  |                     | 545W        | Multi use   | 545            | 625            | 574            | QL200   | 590         |                                      |                               |                                 | 49.1                          | 545A Pilot bit                |
|  | 21.46"              | 24.61"      |             | 22.60"         | NUMA180        | 651            |         |             |                                      |                               |                                 |                               |                               |
|  | SD18                | 689         |             |                |                |                |         |             |                                      |                               |                                 |                               |                               |
|  | 552A                | Single pass | 552         | 625            | 580            | QL200          | 595     | 46.7        |                                      | US552A-18-R-147               |                                 |                               |                               |
|  | 21.73"              |             | 24.61"      | 22.83"         | NUMA180        | 656            |         |             |                                      |                               |                                 |                               |                               |
| SD18   | 694                 |             |             |                |                |                |         |             |                                      |                               |                                 |                               |                               |
| 552W   | Multi use           | 552         | 625         | 580            | QL200          | 595            | 44.3    |             |                                      |                               | 552A Pilot bit                  | UM552W-18-R-434               |                               |
| 21.73"   |                     | 24.61"      | 22.83"      | NUMA180        | 656            |                |         |             |                                      |                               |                                 |                               |                               |
| SD18   | 694                 |             |             |                |                |                |         |             |                                      |                               |                                 |                               |                               |
| <b>CASING PIPE ø711.0mm (28")</b>  |                     |             |             |                |                |                |         |             |                                      |                               |                                 |                               |                               |
| 711.0<br>(28")   | 16.0<br>(0.63")     | 630A        | Single pass | 630            | 726            | 654            | QL200   | 771         | 77.0                                 |                               | US630A-18-R-117<br>*OVER SIZE   |                               |                               |
|  |                     |             |             | 24.80"         | 28.58"         | 25.75"         | NUMA180 | 832         |                                      |                               |                                 |                               |                               |
|  |                     |             |             | SD18           | 870            |                |         |             |                                      |                               |                                 |                               |                               |
|  |                     |             |             | 630            | 726            | 654            | NUMA240 | 1032        |                                      |                               |                                 |                               |                               |
|  |                     | 24.80"      | 28.58"      | 25.75"         |                |                |         |             |                                      |                               |                                 |                               |                               |
|  |                     | 630W        | Multi use   | 630            | 726            | 654            | QL200   | 771         |                                      |                               | 73.0                            | 630A Pilot bit                | UM630W-18-R-429<br>*OVER SIZE |
|  |                     | 24.80"      |             | 28.58"         | 25.75"         | NUMA180        | 832     |             |                                      |                               |                                 |                               |                               |
|  |                     | SD18        |             | 870            |                |                |         |             |                                      |                               |                                 |                               |                               |
|  | 630                 | 726         |             | 654            | NUMA240        | 1032           |         |             |                                      |                               |                                 |                               |                               |
|  | 24.80"              | 28.58"      | 25.75"      |                |                |                |         |             |                                      |                               |                                 |                               |                               |
|  | 630B                | Single pass | 630         | 726            | 654            | QL200          | 771     | 78.0        | 630A Pilot bit                       | US630B-18-R-152<br>*OVER SIZE |                                 |                               |                               |
|  | 24.80"              |             | 28.58"      | 25.75"         | NUMA180        | 832            |         |             |                                      |                               |                                 |                               |                               |
|  | SD18                |             | 870         |                |                |                |         |             |                                      |                               |                                 |                               |                               |
|  | 630                 |             | 726         | 654            | NUMA240        | 1032           |         |             |                                      |                               |                                 |                               |                               |
|  | 24.80"              | 28.58"      | 25.75"      |                |                |                |         |             |                                      |                               |                                 |                               |                               |
|  | 630C                | Single pass | 630         | 726            | 654            | QL200          | 771     |             |                                      | 79.0                          | 630A Pilot bit<br>630A Ring bit | US630C-18-R-426<br>*OVER SIZE |                               |
| 24.80"   | 28.58"              |             | 25.75"      | NUMA180        | 832            |                |         |             |                                      |                               |                                 |                               |                               |
| SD18   | 870                 |             |             |                |                |                |         |             |                                      |                               |                                 |                               |                               |
| 630  | 726                 |             | 654         | NUMA240        | 1032           |                |         |             |                                      |                               |                                 |                               |                               |
| 24.80"   | 28.58"              | 25.75"      |             |                |                |                |         |             |                                      |                               |                                 |                               |                               |
| <b>CASING PIPE ø812.8mm (32")</b> *Please contact us for further discussion. |                     |             |             |                |                |                |         |             |                                      |                               |                                 |                               |                               |
| 812.8<br>(32")   | 16.0<br>(0.63")     | 738A        | Single pass | 738            | 832            | 776            |         |             |                                      |                               |                                 |                               |                               |
|  |                     |             |             | 29.06"         | 32.76"         | 30.55"         |         |             |                                      |                               |                                 |                               |                               |
|  |                     | 738W        | Multi use   | 738            | 832            | 776            |         |             |                                      |                               |                                 |                               |                               |
|  |                     | 29.06"      |             | 32.76"         | 30.55"         |                |         |             |                                      |                               |                                 |                               |                               |
|  | 738B                | Single pass | 738         | 832            | 776            |                |         |             |                                      |                               |                                 |                               |                               |
|  | 29.06"              |             | 32.76"      | 30.55"         |                |                |         |             |                                      |                               |                                 |                               |                               |
| <b>CASING PIPE ø914.4mm (36")</b> *Please contact us for further discussion. |                     |             |             |                |                |                |         |             |                                      |                               |                                 |                               |                               |
| 914.4<br>(36")   | 16.0<br>(0.63")     | 838A        | Single pass | 838            | 932            | 877            |         |             |                                      |                               |                                 |                               |                               |
|  |                     |             |             | 32.99"         | 36.69"         | 34.53"         |         |             |                                      |                               |                                 |                               |                               |
|  |                     | 838W        | Multi use   | 838            | 932            | 877            |         |             |                                      |                               |                                 |                               |                               |
|  |                     | 32.99"      |             | 36.69"         | 34.53"         |                |         |             |                                      |                               |                                 |                               |                               |
| <b>CASING PIPE ø1016mm (40")</b> *Please contact us for further discussion.  |                     |             |             |                |                |                |         |             |                                      |                               |                                 |                               |                               |
| 1016<br>(40")  | 16.0<br>(0.63")     | 920A        | Single pass | 920            | 1035           | 973            |         |             |                                      |                               |                                 |                               |                               |
|  |                     |             |             | 36.22"         | 40.75"         | 38.31"         |         |             |                                      |                               |                                 |                               |                               |
|  |                     | 920W        | Multi use   | 920            | 1035           | 973            |         |             |                                      |                               |                                 |                               |                               |
|  |                     | 36.22"      |             | 40.75"         | 38.31"         |                |         |             |                                      |                               |                                 |                               |                               |

\*Over size : No shank breakage warranty.

# DIMENSIONS

## Big Bore Type ULTRA MAXBIT / DTH

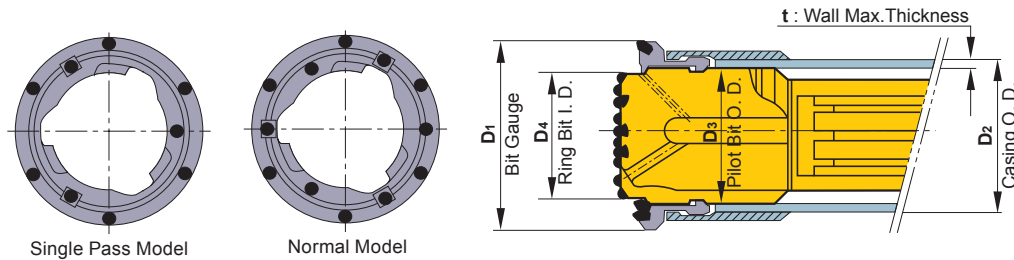

Unit: mm (Upper)  
inch (Bottom)

| Casing Pipe                          |                                  | Type           | Ring Bit                         |                                  |                              | Pilot Bit                    |        |             | Ring Set<br>(Ring Bit & Casing Shoe) | Compatible Part | System Part Number |                 |  |                       |  |
|--------------------------------------|----------------------------------|----------------|----------------------------------|----------------------------------|------------------------------|------------------------------|--------|-------------|--------------------------------------|-----------------|--------------------|-----------------|--|-----------------------|--|
| Outer Dia.<br>D <sub>2</sub>         | Wall Max. Thickness<br>t         |                | Model                            | Inner Dia.<br>D <sub>4</sub>     | Outer Dia.<br>D <sub>1</sub> | Outer Dia.<br>D <sub>3</sub> | Hammer | Weight (kg) |                                      |                 |                    | Weight (kg)     |  |                       |  |
| <b>CASING PIPE ø114.3mm (4 1/2")</b> |                                  |                |                                  |                                  |                              |                              |        |             |                                      |                 |                    |                 |  |                       |  |
| 114.3<br>(4 1/2")                    | 8.0<br>(0.31")                   | 086L           | Single pass<br>for RD-pile       | 86                               | 137                          | 96                           | DHD3.5 | 6.9         | 4.8                                  |                 | UB086L-03-R-222    |                 |  |                       |  |
|                                      |                                  |                |                                  | 3.39"                            | 5.39"                        | 3.78"                        | COP34  | 7.5         |                                      |                 |                    |                 |  |                       |  |
|                                      |                                  |                |                                  |                                  |                              |                              | COP32  | 6.9         |                                      |                 |                    |                 |  |                       |  |
|                                      |                                  |                |                                  |                                  |                              |                              | 86     | 137         | 96                                   | W80             | 7.8                | 4.8             |  | UB086LW80R280<br>*1   |  |
|                                      |                                  |                |                                  | 3.39"                            | 5.39"                        | 3.78"                        |        |             |                                      |                 |                    |                 |  |                       |  |
| 114.3<br>(4 1/2")                    | 5.6<br>(0.22")                   | 092L           | Large bore hole<br>(Single pass) | 92                               | 137                          | 101.5                        | DHD3.5 | 8.6         | 4.4                                  |                 | UB092L-03-R-229    |                 |  |                       |  |
|                                      |                                  |                |                                  | 3.62"                            | 5.39"                        | 4.00"                        | COP34  | 9.2         |                                      |                 |                    |                 |  |                       |  |
|                                      |                                  |                |                                  |                                  |                              |                              | COP32  | 8.6         |                                      |                 |                    |                 |  |                       |  |
|                                      |                                  |                |                                  |                                  |                              |                              |        |             |                                      |                 |                    |                 |  |                       |  |
|                                      |                                  |                |                                  | 92                               | 137                          | 101.5                        |        |             |                                      |                 |                    |                 |  |                       |  |
|                                      |                                  |                |                                  | 3.62"                            | 5.39"                        | 4.00"                        |        |             |                                      |                 |                    |                 |  |                       |  |
| <b>CASING PIPE ø139.7mm (5 1/2")</b> |                                  |                |                                  |                                  |                              |                              |        |             |                                      |                 |                    |                 |  |                       |  |
| 139.7<br>(5 1/2")                    | 10.0<br>(0.39")                  | 106L           | Single pass<br>for RD-pile       | 106                              | 166                          | 118                          | DHD340 | 10.7        | 7.7                                  |                 | UB106L-04-R-223    |                 |  |                       |  |
|                                      |                                  |                |                                  | 4.17"                            | 6.54"                        | 4.65"                        | QL40   | 12.0        |                                      |                 |                    |                 |  |                       |  |
|                                      |                                  |                |                                  |                                  |                              |                              | SD4    | 11.8        |                                      |                 |                    |                 |  |                       |  |
|                                      |                                  |                |                                  |                                  |                              |                              | 106    | 166         | 118                                  | W100            | 10.7               | 7.7             |  | UB106LW1034R226<br>*1 |  |
|                                      |                                  |                |                                  |                                  |                              |                              |        | 4.17"       | 6.54"                                | 4.65"           |                    |                 |  |                       |  |
|                                      |                                  |                |                                  |                                  |                              |                              |        |             |                                      |                 |                    |                 |  |                       |  |
| 139.7<br>(5 1/2")                    | 5.6<br>(0.22")                   | 116L           | Large bore hole<br>(Single pass) | 116                              | 161                          | 127                          | DHD340 | 13.7        | 5.4                                  |                 | UB116L-04-R-230    |                 |  |                       |  |
|                                      |                                  |                |                                  | 4.57"                            | 6.34"                        | 5.00"                        | QL40   | 15.0        |                                      |                 |                    |                 |  |                       |  |
|                                      |                                  |                |                                  |                                  |                              |                              | SD4    | 14.8        |                                      |                 |                    |                 |  |                       |  |
|                                      |                                  | 118L           | Large bore hole<br>(Single pass) | 118                              | 161                          | 127                          | DHD340 | 14.0        | 5.3                                  |                 | UB118L-04-R-335    |                 |  |                       |  |
|                                      |                                  |                |                                  | 4.65"                            | 6.34"                        | 5.00"                        | QL40   | 15.3        |                                      |                 |                    |                 |  |                       |  |
|                                      |                                  |                |                                  |                                  |                              |                              | SD4    | 15.1        |                                      |                 |                    |                 |  |                       |  |
|                                      |                                  |                |                                  |                                  |                              |                              |        |             |                                      |                 |                    |                 |  |                       |  |
|                                      |                                  |                |                                  | 116                              | 161                          | 127                          |        |             |                                      |                 |                    |                 |  |                       |  |
|                                      |                                  |                |                                  | 4.57"                            | 6.34"                        | 5.00"                        |        |             |                                      |                 |                    |                 |  |                       |  |
| <b>CASING PIPE ø168.3mm (6 5/8")</b> |                                  |                |                                  |                                  |                              |                              |        |             |                                      |                 |                    |                 |  |                       |  |
| 168.3<br>(6 5/8")                    | 12.5<br>(0.49")                  | 127L           | Single pass<br>for RD-pile       | 127                              | 195                          | 141                          | DHD350 | 20.0        | 9.7                                  |                 | UB127L-05-R-224    |                 |  |                       |  |
|                                      |                                  |                |                                  | 5.00"                            | 7.68"                        | 5.55"                        | QL50   | 19.5        |                                      |                 |                    |                 |  |                       |  |
|                                      |                                  |                |                                  |                                  |                              |                              | SD5    | 19.4        |                                      |                 |                    |                 |  |                       |  |
|                                      |                                  |                |                                  |                                  |                              |                              | 127    | 195         | 141                                  | W120            | 19.8               | 9.7             |  | UB127LW1235R227<br>*1 |  |
|                                      |                                  |                |                                  |                                  |                              |                              |        | 5.00"       | 7.68"                                | 5.55"           |                    |                 |  |                       |  |
|                                      |                                  |                |                                  |                                  |                              |                              |        |             |                                      |                 |                    |                 |  |                       |  |
|                                      | 168.3<br>(6 5/8")                | 6.3<br>(0.25") | 141M                             | Large bore hole<br>(Single pass) | 141                          | 189                          | 154    | DHD350      | 24.5                                 | 6.7             | 141L Ring set      | UB141M-05-R-247 |  |                       |  |
|                                      |                                  |                |                                  |                                  | 5.55"                        | 7.44"                        | 6.06"  | QL50        | 24.0                                 |                 |                    |                 |  |                       |  |
|                                      |                                  |                |                                  |                                  |                              |                              |        | SD5         | 23.9                                 |                 |                    |                 |  |                       |  |
|                                      |                                  |                | 141M                             | Large bore hole<br>(Single pass) | 141                          | 189                          | 154    | DHD350      | 24.5                                 | 7.0             |                    | UB141M-05-R-246 |  |                       |  |
|                                      |                                  |                |                                  |                                  | 5.55"                        | 7.44"                        | 6.06"  | QL50        | 24.0                                 |                 |                    |                 |  |                       |  |
|                                      |                                  |                |                                  |                                  |                              |                              |        | SD5         | 23.9                                 |                 |                    |                 |  |                       |  |
|                                      |                                  |                |                                  |                                  |                              |                              |        |             |                                      |                 |                    |                 |  |                       |  |
| 168.3<br>(6 5/8")                    | 5.6<br>(0.22")                   | 141L           | Large bore hole<br>(Single pass) | 141                              | 189                          | 155                          | DHD350 | 24.5        | 6.7                                  |                 | UB141L-05-R-231    |                 |  |                       |  |
|                                      |                                  |                |                                  | 5.55"                            | 7.44"                        | 6.10"                        | QL50   | 24.0        |                                      |                 |                    |                 |  |                       |  |
|                                      |                                  |                |                                  |                                  |                              |                              | SD5    | 23.9        |                                      |                 |                    |                 |  |                       |  |
|                                      |                                  | 141L           | Large bore hole<br>(Single pass) | 141                              | 189                          | 155                          | DHD350 | 24.5        | 6.7                                  |                 | UB141L-05-R-276    |                 |  |                       |  |
|                                      |                                  |                |                                  | 5.55"                            | 7.44"                        | 6.10"                        | QL50   | 24.0        |                                      |                 |                    |                 |  |                       |  |
|                                      |                                  |                |                                  |                                  |                              |                              | SD5    | 23.9        |                                      |                 |                    |                 |  |                       |  |
| 143L                                 | Large bore hole<br>(Single pass) | 143            | 189                              | 155                              | DHD350                       | 25.0                         | 6.6    |             | UB143L-05-R-336                      |                 |                    |                 |  |                       |  |
|                                      |                                  | 5.63"          | 7.44"                            | 6.10"                            | QL50                         | 24.5                         |        |             |                                      |                 |                    |                 |  |                       |  |
|                                      |                                  |                |                                  |                                  | SD5                          | 24.4                         |        |             |                                      |                 |                    |                 |  |                       |  |
|                                      |                                  |                |                                  |                                  |                              |                              |        |             |                                      |                 |                    |                 |  |                       |  |
|                                      |                                  |                |                                  | 141                              | 189                          | 155                          |        |             |                                      |                 |                    |                 |  |                       |  |
|                                      |                                  |                |                                  | 5.55"                            | 7.44"                        | 6.10"                        |        |             |                                      |                 |                    |                 |  |                       |  |
| <b>CASING PIPE ø177.8mm (7")</b>     |                                  |                |                                  |                                  |                              |                              |        |             |                                      |                 |                    |                 |  |                       |  |
| 177.8<br>(7")                        | 7.0<br>(0.28")                   | 153L           | Large bore hole<br>(Normal)      | 153                              | 200                          | 162                          | DHD360 | 31.2        | 7.2                                  |                 | UB153L-06-R-244    |                 |  |                       |  |
|                                      |                                  |                |                                  | 6.02"                            | 7.87"                        | 6.38"                        | QL60   | 30.7        |                                      |                 |                    |                 |  |                       |  |
|                                      |                                  |                |                                  |                                  |                              |                              | SD6    | 33.7        |                                      |                 |                    |                 |  |                       |  |
|                                      |                                  | 154L           | Large bore hole<br>(Normal)      | 154                              | 200                          | 162                          | DHD360 | 31.0        | 7.1                                  |                 | UB154L-06-R-260    |                 |  |                       |  |
|                                      |                                  |                |                                  | 6.06"                            | 7.87"                        | 6.38"                        | QL60   | 30.5        |                                      |                 |                    |                 |  |                       |  |
|                                      |                                  |                |                                  |                                  |                              |                              | SD6    | 33.5        |                                      |                 |                    |                 |  |                       |  |
|                                      |                                  |                |                                  |                                  |                              |                              |        |             |                                      |                 |                    |                 |  |                       |  |
|                                      |                                  |                |                                  | 153                              | 200                          | 162                          |        |             |                                      |                 |                    |                 |  |                       |  |
|                                      |                                  |                |                                  | 6.02"                            | 7.87"                        | 6.38"                        |        |             |                                      |                 |                    |                 |  |                       |  |

\*1 Actual hammer model.

Note 1) To order, please advise the system type, casing size / hammer size and the ring bit models.  
Note 2) Special types are also available according to customer's request.



# Big Bore Type ULTRA MAXBIT / DTH

## System Part Number

### U B 086L - 03 - R - 222

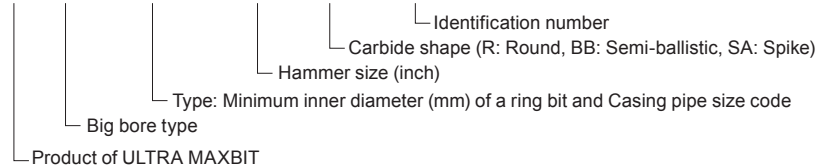

Unit: mm (Upper)  
inch (Bottom)

| Casing Pipe                            |                          | Type                             | Ring Bit                         |                              |                              | Pilot Bit                    |        |             | Ring Set<br>(Ring Bit & Casing Shoe) | Compatible Part       | System Part Number    |             |       |  |
|--|--------------------------|----------------------------------|----------------------------------|------------------------------|------------------------------|------------------------------|--------|-------------|--------------------------------------|-----------------------|-----------------------|-------------|-------|--|
| Outer Dia.<br>D <sub>2</sub>           | Wall Max. Thickness<br>t |                                  | Model                            | Inner Dia.<br>D <sub>4</sub> | Outer Dia.<br>D <sub>1</sub> | Outer Dia.<br>D <sub>3</sub> | Hammer | Weight (kg) |                                      |                       |                       | Weight (kg) |       |  |
| <b>CASING PIPE ø193.7mm (7 5/8")</b>   |                          |                                  |                                  |                              |                              |                              |        |             |                                      |                       |                       |             |       |  |
| 193.7<br>(7 5/8")                      | 10.0<br>(0.39")          | 162L                             | Large bore hole<br>(Single pass) | 162                          | 215                          | 172                          | W150   | 31.0        | 8.8                                  |                       | UB162LW1536R232<br>*1 |             |       |  |
|  |                          |                                  |                                  | 6.38"                        | 8.46"                        | 6.77"                        |        |             |                                      |                       |                       |             |       |  |
|  | 6.3<br>(0.25")           | 167L                             | Large bore hole<br>(Single pass) | 167                          | 215                          | 179                          | DHD360 | 35.0        | 8.1                                  |                       | UB167L-06-R-233       |             |       |  |
|  |                          |                                  |                                  | 6.57"                        | 8.46"                        | 7.05"                        | QL60   | 34.5        |                                      |                       |                       |             |       |  |
|  |                          |                                  |                                  | 167                          | 215                          | 179                          | W150   | 35.0        | 8.1                                  | UB167LW1536R234<br>*1 |                       |             |       |  |
|  |                          |                                  |                                  | 6.57"                        | 8.46"                        | 7.05"                        |        |             |                                      |                       |                       |             |       |  |
| <b>CASING PIPE ø216.3mm (8 17/32")</b> |                          |                                  |                                  |                              |                              |                              |        |             |                                      |                       |                       |             |       |  |
| 216.3<br>(8 17/32")                    | 8.2<br>(0.32")           | 187M                             | Large bore hole<br>(Single pass) | 187                          | 235                          | 197                          | W151   | 40.0        | 8.8                                  | 187L Pilot bit        | UB187MW1536R292<br>*1 |             |       |  |
|  |                          |                                  |                                  | 7.36"                        | 9.25"                        | 7.76"                        |        |             |                                      |                       |                       |             |       |  |
| <b>CASING PIPE ø219.1mm (8 5/8")</b>   |                          |                                  |                                  |                              |                              |                              |        |             |                                      |                       |                       |             |       |  |
| 219.1<br>(8 5/8")                      | 12.5<br>(0.49")          | 177L                             | Single pass<br>for RD-pile       | 177                          | 250                          | 191                          | DHD360 | 33.5        | 13.6                                 |                       | UB177L-06-R-225       |             |       |  |
|  |                          |                                  |                                  | 6.97"                        | 9.84"                        | 7.52"                        |        |             |                                      |                       |                       | QL60        | 33.0  |  |
|  |                          |                                  |                                  |                              |                              |                              |        |             |                                      |                       |                       |             |       |  |
|  |                          |                                  |                                  |                              |                              |                              |        |             |                                      |                       |                       |             |       |  |
|  | 10.0<br>(0.39")          | 187L                             | Single pass<br>for RD-pile       | 187                          | 252                          | 197                          | DHD360 | 40.0        | 11.9                                 |                       | UB187L-06-R-255       |             |       |  |
|  |                          |                                  |                                  | 7.36"                        | 9.92"                        | 7.76"                        |        |             |                                      |                       |                       | QL60        | 39.5  |  |
|  |                          |                                  |                                  |                              |                              |                              |        |             |                                      |                       |                       |             |       |  |
|  |                          |                                  |                                  |                              |                              |                              |        |             |                                      |                       |                       |             |       |  |
| 6.3<br>(0.25")                         | 192L                     | Large bore hole<br>(Single pass) | 192                              | 242                          | 204                          | DHD360                       | 41.5   | 9.4         | UB192L-06-R-235                      |                       |                       |             |       |  |
|  |                          |                                  | 7.56"                            | 9.53"                        | 8.03"                        |                              |        |             |                                      | QL60                  | 41.0                  |             |       |  |
|  |                          |                                  |                                  |                              |                              |                              |        |             |                                      |                       |                       |             |       |  |
|  |                          |                                  |                                  |                              |                              |                              |        |             |                                      |                       |                       |             |       |  |
| <b>CASING PIPE ø273.0mm (10 3/4")</b>  |                          |                                  |                                  |                              |                              |                              |        |             |                                      |                       |                       |             |       |  |
| 273.0<br>(10 3/4")                     | 12.7<br>(0.50")          | 232L                             | Large bore hole<br>(Single pass) | 232                          | 297                          | 245                          | W150   | 60.0        | 16.4                                 |                       | UB232LW1536R254<br>*1 |             |       |  |
|  |                          |                                  |                                  | 9.13"                        | 11.69"                       | 9.65"                        |        |             |                                      |                       |                       |             |       |  |
|  | 10.0<br>(0.39")          | 238L                             | Large bore hole<br>(Single pass) | 238                          | 297                          | 251                          | W150   | 65.0        | 14.9                                 |                       | UB232LW1536R236<br>*1 |             |       |  |
|  |                          |                                  |                                  | 9.37"                        | 11.69"                       | 9.88"                        |        |             |                                      |                       |                       |             |       |  |
|  | 8.0<br>(0.31")           | 242L                             | Large bore hole<br>(Single pass) | 242                          | 297                          | 255                          | DHD380 | 81.0        | 13.8                                 |                       | UB242L-08-R-237       |             |       |  |
|  |                          |                                  |                                  | 9.53"                        | 11.69"                       | 10.04"                       |        |             |                                      |                       |                       | QL80        | 80.6  |  |
|  |                          |                                  |                                  |                              |                              |                              |        |             |                                      |                       |                       |             |       |  |
|  |                          |                                  |                                  |                              |                              |                              |        |             |                                      |                       |                       |             |       |  |
| <b>CASING PIPE ø323.9mm (12 3/4")</b>  |                          |                                  |                                  |                              |                              |                              |        |             |                                      |                       |                       |             |       |  |
| 323.9<br>(12 3/4")                     | 10.0<br>(0.39")          | 284L                             | Large bore hole<br>(Single pass) | 284                          | 350                          | 301                          | DHD380 | 104.5       | 20.0                                 |                       | UB284L-08-R-238       |             |       |  |
|  |                          |                                  |                                  | 11.18"                       | 13.78"                       | 11.85"                       |        |             |                                      |                       |                       | QL80        | 104.1 |  |
|  |                          |                                  |                                  |                              |                              |                              | SD8    | 97.9        |                                      |                       |                       |             |       |  |
|  |                          |                                  |                                  |                              |                              |                              |        |             |                                      |                       |                       |             |       |  |
| <b>CASING PIPE ø355.6mm (14")</b>      |                          |                                  |                                  |                              |                              |                              |        |             |                                      |                       |                       |             |       |  |
| 355.6<br>(14")                         | 10.0<br>(0.39")          | 315L                             | Large bore hole<br>(Single pass) | 315                          | 380                          | 332                          | DHD380 | 163.5       | 21.1                                 |                       | UB315L-12-R-355       |             |       |  |
|  |                          |                                  |                                  | 12.40"                       | 14.96"                       | 13.07"                       |        |             |                                      |                       |                       | QL80        | 163.1 |  |
|  |                          |                                  |                                  |                              |                              |                              | SD8    | 156.9       |                                      |                       |                       |             |       |  |
|  |                          |                                  |                                  |                              |                              |                              |        |             |                                      |                       |                       |             |       |  |

\*1 Actual hammer model.

\*2 Over size : No shank breakage warranty.

# DIMENSIONS

## Top Hammer Type ULTRA MAXBIT / Top Hammer

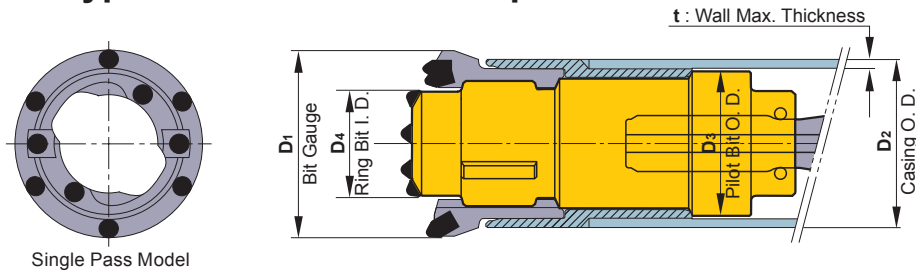

Unit: mm (Upper)  
inch (Bottom)

| Casing Pipe                         |                                  | Type            | Ring Bit    |                              |                              | Pilot Bit                    |             |             | Ring Set<br>(Ring Bit & Casing Shoe) | Compatible Part                                    | System Part Number                |
|-------------------------------------|----------------------------------|-----------------|-------------|------------------------------|------------------------------|------------------------------|-------------|-------------|--------------------------------------|--|-----------------------------------|
| Outer Dia.<br>D <sub>2</sub>        | Wall Max. Thickness<br>t         |                 | Model       | Inner Dia.<br>D <sub>4</sub> | Outer Dia.<br>D <sub>1</sub> | Outer Dia.<br>D <sub>3</sub> | Thread      | Weight (kg) |                                      |  |                                   |
| <b>CASING PIPE ø76.3mm (3")</b>     |                                  |                 |             |                              |                              |                              |             |             |                                      |  |                                   |
| 76.3<br>(3")                        | 8.0<br>(0.31")                   | 042A            | Single pass | 42<br>1.65"                  | 86<br>3.39"                  | 58.5<br>2.30"                | R32         | 1.8         | 2.3                                  | UT042AR32BBL370                                    |                                   |
| <b>CASING PIPE ø88.9mm (3 1/2")</b> |                                  |                 |             |                              |                              |                              |             |             |                                      |  |                                   |
| 88.9<br>(3 1/2")                    | 9.5<br>(0.37")                   | 050B            | Single pass | 50<br>1.97"                  | 95<br>3.74"                  | 67.5<br>2.66"                | T38         | 3.3         | 2.9                                  | 050A Ring bit<br>UT050BM38BBL304                   |                                   |
|                                     |                                  | 050B            | Single pass | 50<br>1.97"                  | 100<br>3.94"                 | 67.5<br>2.66"                | T38         | 3.3         | 3.1                                  | UT050BM38BBL168                                    |                                   |
|                                     | 8.0<br>(0.31")                   | 050A            | Single pass | 50<br>1.97"                  | 95<br>3.74"                  | 67.5<br>2.66"                | T38         | 3.3         | 2.9                                  | 050B Pilot bit<br>UT050AM38BBL323                  |                                   |
|                                     |                                  | 050A            | Single pass | 50<br>1.97"                  | 100<br>3.94"                 | 67.5<br>2.66"                | T38         | 3.3         | 3.1                                  | 050B Pilot bit<br>050B Ring bit<br>UT050AM38BBL324 |                                   |
|                                     | 7.0<br>(0.28")                   | 050C            | Single pass | 50<br>1.97"                  | 95<br>3.74"                  | 67.5<br>2.66"                | T38         | 3.3         | 3.0                                  | 050B Pilot bit<br>050A Ring bit<br>UT050CM38BBL305 |                                   |
|                                     |                                  |                 | Single pass | 50<br>1.97"                  | 100<br>3.94"                 | 67.5<br>2.66"                | T38         | 3.3         | 3.2                                  | 050B Pilot bit<br>050B Ring bit<br>UT050CM38BBL303 |                                   |
|                                     |                                  | 056E            | Single pass | 56<br>2.20"                  | 100<br>3.94"                 | 73.5<br>2.89"                | T38         | 3.5         | 2.4                                  | UT056EM38BBL268                                    |                                   |
|                                     | 6.35<br>(0.25")                  | 056B            | Single pass | 56<br>2.20"                  | 100<br>3.94"                 | 74<br>2.91"                  | T38         | 3.6         | 2.6                                  | 056A Ring bit<br>UT056BM38BBL140                   |                                   |
|                                     | 4.0<br>(0.16")                   | 056A            | Single pass | 56<br>2.20"                  | 100<br>3.94"                 | 78<br>3.07"                  | T38         | 3.5         | 2.6                                  | UT056AM38BBL133                                    |                                   |
|                                     | <b>CASING PIPE ø101.6mm (4")</b> |                 |             |                              |                              |                              |             |             |                                      |  |                                   |
|                                     | 101.6<br>(4")                    | 10.0<br>(0.39") | 060D        | Single pass                  | 60<br>2.36"                  | 114<br>4.49"                 | 79<br>3.11" | T38         | 4.5                                  | 4.0  | 060A Pilot bit<br>UT060DM38BBL359 |
|                                     |                                  | 9.5<br>(0.37")  | 060A        | Single pass                  | 60<br>2.36"                  | 114<br>4.49"                 | 81<br>3.19" | T38         | 4.6                                  | 4.0  | UT060AM38BBL306                   |
| Single pass                         |                                  |                 |             | 60<br>2.36"                  | 114<br>4.49"                 | 81<br>3.19"                  | T38         | 4.6         | 4.1                                  | 060A Pilot bit<br>060A Ring bit<br>UT060BM38BBL307 |                                   |
| 8.0<br>(0.31")                      |                                  | 060C            | Single pass | 60<br>2.36"                  | 114<br>4.49"                 | 81<br>3.19"                  | T38         | 4.6         | 4.2                                  | 060A Pilot bit<br>060A Ring bit<br>UT060CM38BBL325 |                                   |
|                                     |                                  |                 | 065A        | Single pass                  | 65<br>2.56"                  | 114<br>4.49"                 | 85<br>3.35" | T38         | 5.3                                  | 3.6  | UT065AM38BBL269                   |

Note 1) To order, please advise the system type, casing size / thread size and the ring bit models.

Note 2) Special types are also available according to customer's request.

# Top Hammer Type ULTRA MAXBIT / Top Hammer

## System Part Number

**U T 072A M38 BB L095**

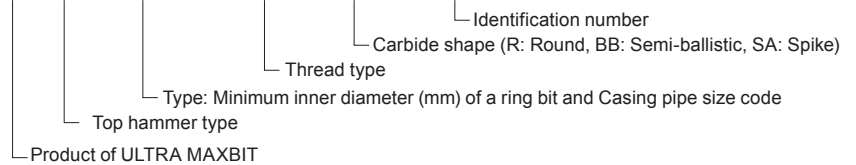

Unit: mm (Upper)  
inch (Bottom)

| Casing Pipe                          |                          | Type        | Ring Bit    |                              |                              | Pilot Bit                    |        |             | Ring Set<br>(Ring Bit & Casing Shoe) | Compatible Part                 | System Part Number |                 |
|--------------------------------------|--------------------------|-------------|-------------|------------------------------|------------------------------|------------------------------|--------|-------------|--------------------------------------|---------------------------------|--------------------|-----------------|
| Outer Dia.<br>D <sub>2</sub>         | Wall Max. Thickness<br>t |             | Model       | Inner Dia.<br>D <sub>4</sub> | Outer Dia.<br>D <sub>1</sub> | Outer Dia.<br>D <sub>3</sub> | Thread | Weight (kg) |                                      |                                 |                    |                 |
| <b>CASING PIPE ø114.3mm (4 1/2")</b> |                          |             |             |                              |                              |                              |        |             |                                      |                                 |                    |                 |
| 114.3<br>(4 1/2")                    | 10.0<br>(0.39")          | 072A        | Single pass | 72                           | 126                          | 92                           | T38    | 6.0         | 4.7                                  |                                 | UT072AM38BBL095    |                 |
|                                      |                          |             |             | 2.83"                        | 4.96"                        | 3.62"                        |        |             |                                      |                                 |                    |                 |
|                                      |                          |             |             | 72                           | 126                          | 92                           | T45    | 6.2         | 4.7                                  |                                 |                    | UT072AM45BBL106 |
|                                      |                          |             |             | 2.83"                        | 4.96"                        | 3.62"                        |        |             |                                      |                                 |                    |                 |
|                                      | 9.5<br>(0.37")           | 072C        | Single pass | 72                           | 126                          | 93                           | T38    | 6.7         | 4.7                                  | UT072CM38BBL308                 |                    |                 |
|                                      |                          |             |             | 2.83"                        | 4.96"                        | 3.66"                        |        |             |                                      |                                 |                    |                 |
|                                      |                          |             |             | 72                           | 126                          | 93                           | T45    | 6.9         | 4.7                                  |                                 | UT072CM45BBL362    |                 |
|                                      |                          |             |             | 2.83"                        | 4.96"                        | 3.66"                        |        |             |                                      |                                 |                    |                 |
|                                      | 8.0<br>(0.31")           | 072D        | Single pass | 72                           | 126                          | 93                           | T38    | 6.7         | 4.8                                  | 072C Pilot bit<br>072C Ring bit |                    | UT072DM38BBL309 |
|                                      |                          |             |             | 2.83"                        | 4.96"                        | 3.66"                        |        |             |                                      |                                 |                    |                 |
|                                      |                          |             |             | 72                           | 126                          | 93                           | T45    | 6.9         | 4.8                                  | 072C Pilot bit<br>072C Ring bit | UT072DM45BBL363    |                 |
|                                      |                          |             |             | 2.83"                        | 4.96"                        | 3.66"                        |        |             |                                      |                                 |                    |                 |
| 7.0<br>(0.28")                       | 072E                     | Single pass | 72          | 126                          | 93                           | T38                          | 6.7    | 4.9         | 072C Pilot bit<br>072C Ring bit      | UT072EM38BBL326                 |                    |                 |
|                                      |                          |             | 2.83"       | 4.96"                        | 3.66"                        |                              |        |             |                                      |                                 |                    |                 |
|                                      |                          |             | 72          | 126                          | 93                           | T45                          | 6.7    | 4.9         | 072C Pilot bit<br>072C Ring bit      |                                 | UT072EM45BBL364    |                 |
|                                      |                          |             | 2.83"       | 4.96"                        | 3.66"                        |                              |        |             |                                      |                                 |                    |                 |
|                                      | 076B                     | Single pass | 76          | 126                          | 98                           | T38                          | 7.2    | 4.3         |                                      | UT076BM38BBL270                 |                    |                 |
|                                      |                          |             | 2.99"       | 4.96"                        | 3.86"                        |                              |        |             |                                      |                                 |                    |                 |
| <b>CASING PIPE ø139.7mm (5 1/2")</b> |                          |             |             |                              |                              |                              |        |             |                                      |                                 |                    |                 |
| 139.7<br>(5 1/2")                    | 10.0<br>(0.39")          | 097A        | Single pass | 97                           | 150                          | 117.5                        | T45    | 11.7        | 5.7                                  |                                 | UT097AM45BBL096    |                 |
|                                      |                          |             |             | 3.82"                        | 5.91"                        | 4.63"                        |        |             |                                      |                                 |                    |                 |
|                                      |                          |             |             | 97                           | 150                          | 117.5                        | T51    | 11.9        | 5.7                                  |                                 |                    | UT097AM51BBL365 |
|                                      |                          |             |             | 3.82"                        | 5.91"                        | 4.63"                        |        |             |                                      |                                 |                    |                 |
|                                      | 9.5<br>(0.37")           | 097C        | Single pass | 97                           | 150                          | 118.5                        | T38    | 12.0        | 5.9                                  | 097B Pilot bit<br>097A Ring bit | UT097CM38BBL327    |                 |
|                                      |                          |             |             | 3.82"                        | 5.91"                        | 4.66"                        |        |             |                                      |                                 |                    |                 |
|                                      | 8.0<br>(0.31")           | 097B        | Single pass | 97                           | 150                          | 118.5                        | T38    | 12.0        | 5.9                                  | 097A Ring bit                   |                    | UT097BM38BBL311 |
|                                      |                          |             |             | 3.82"                        | 5.91"                        | 4.67"                        |        |             |                                      |                                 |                    |                 |
|                                      |                          |             |             | 97                           | 150                          | 118.5                        | T45    | 11.7        | 5.9                                  | 097A Ring bit                   | UT097BM45BBL141    |                 |
|                                      |                          |             |             | 3.82"                        | 5.91"                        | 4.67"                        |        |             |                                      |                                 |                    |                 |
|                                      | 7.0<br>(0.28")           | 097D        | Single pass | 97                           | 150                          | 118.5                        | T38    | 12.0        | 5.9                                  | 097B Pilot bit<br>097A Ring bit |                    | UT097DM38BBL328 |
|                                      |                          |             |             | 3.82"                        | 5.91"                        | 4.67"                        |        |             |                                      |                                 |                    |                 |
| 6.6<br>(0.26")                       | 100B                     | Single pass | 97          | 150                          | 123                          | T38                          | 13.0   | 5.8         |                                      | UT100BM38BBL338                 |                    |                 |
|                                      |                          |             | 3.82"       | 5.91"                        | 4.84"                        |                              |        |             |                                      |                                 |                    |                 |

## Rotation Speed of Bit

Standard speed is 15–20m/min.  
Refer to the following figure for rotation.  
Select the range of uniform rotation during drilling.

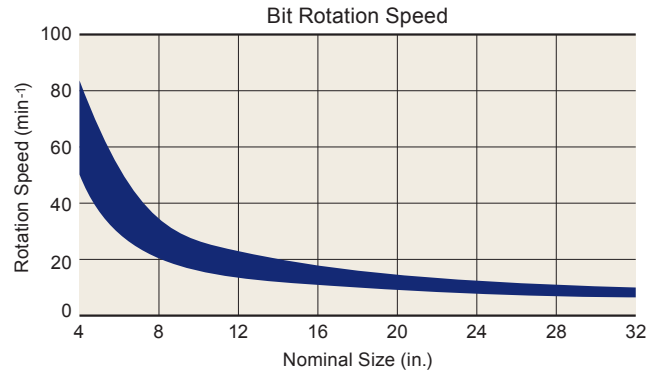

## Setting Compressor

- Pressure
  - Set between 0.7 to 1.0MPa (100–150psi)
  - Consider the depth of underground water when drilling through the layer.  
(In case of 30m (90 ft) depth, add 0.3MPa (45psi) to the air pressure.)
  - Do not set over 1.5MPa (225psi)
- Air Consumption
  - Set the air supply using the following formula.

$$Q = \frac{V(D^2 - d^2)}{1273500}$$

Q : Air supply (m³/min)  
D : Inside diameter of casing (mm)  
d : Outside diameter of jacket or hammer (mm)  
V : Air speed 1,100–1,500 (m/min)

Recommended Air Consumption

| Nominal Size<br>(in.) | Air Supply |             |
|-----------------------|------------|-------------|
|                       | (m³/min)   | (cfm)       |
| 4                     | 4-15       | 140-530     |
| 8                     | 19-26      | 670-920     |
| 12                    | 33-45      | 1,170-1,590 |
| 16                    | 42-57      | 1,480-2,010 |
| 20                    | 59-80      | 2,080-2,830 |
| 24                    | 72-98      | 2,540-3,460 |
| 28                    | 81-111     | 2,860-3,920 |
| 32                    | 90-122     | 3,180-4,310 |

## APPLICATION EXAMPLES

### ULTRA MAXBIT for RD Pile

- Face of the pilot bit is located at same level of ring bit.  
(Pilot bit does not protrude from the ring bit like other standard ULTRA MAXBIT system)  
This structure make the system stronger against the heavy weight from RD pile.
- Ring bit is bigger than the diameter of "Threaded sleeve splice" shown below illustration for soother drilling.
- Minimum width of the ring bit is same as the width of casing pipe to retain enough strength of RD pile.

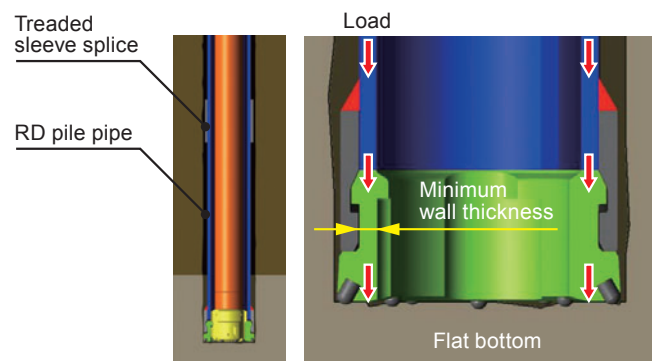

# APPLICATION EXAMPLES

## Foundation construction

Used for improving foundation or for inserting H steel beams.



## Micro pile construction

Possible to efficiently drill in underpinning.



## Well drilling construction

The normal model is recommended if a casing pipe is left in the ground. If not, the multi-use model is recommended.



## Pipe roof and Tunnel fore piling

Efficient and stable operation is possible in inclined or horizontal casing drilling.



# ULTRA MAXBIT

## ORDER SHEET

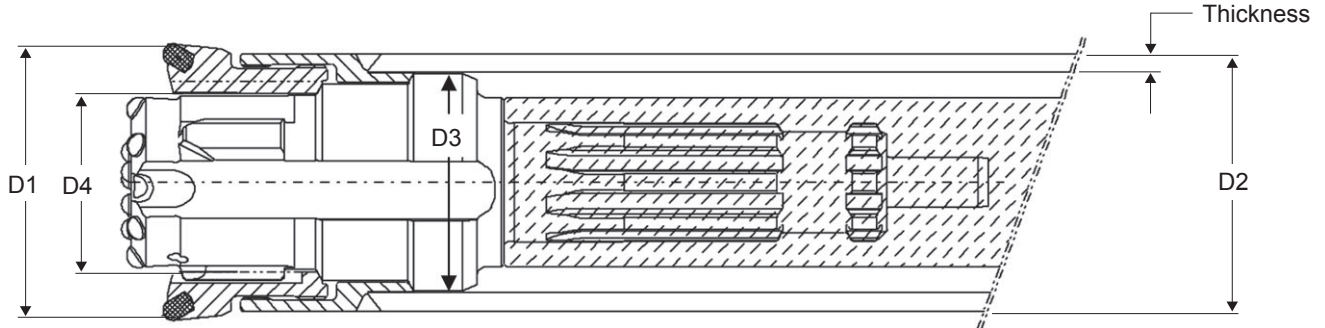

|                                |   |  |
|--------------------------------|---|--|
| User Name                      |   |  |
| Usage                          |   |  |
| "DTH Model No. or Thread type" |   |  |
| Rotation Direction at Drilling | <input type="checkbox"/> Right  | <input type="checkbox"/> Left  |
| Drilling Direction             | <input type="checkbox"/> Vertical   | <input type="checkbox"/> Horizontal <input type="checkbox"/> Diagonal (Angled) |
| Casing Pipe                    | Outer diameter (D2)   | Wall max. thickness  |
| UMB System                     | <input type="checkbox"/> Standard   | <input type="checkbox"/> Big bore <input type="checkbox"/> Top hammer          |
| Ring Bit Model                 | <input type="checkbox"/> Single pass  | <input type="checkbox"/> Normal <input type="checkbox"/> Multi use             |
| Ring Bit O.D.                  | (D1)  | <input type="checkbox"/> Manufacturer's recommendation                         |
| Ring Bit I.D.                  | (D4)  | <input type="checkbox"/> Manufacturer's recommendation                         |
| Maximum O.D. of Pilot Bit      | (D3)  | <input type="checkbox"/> Manufacturer's recommendation                         |
| Quantity Demanded              | Drilling meter / Number of hole   |  |
| Minimum Order Quantity         | Pilot Bit: Ring Bit & Casing Shoe:  |  |
| Expected Delivery Time         |   |  |
| Remark                         | Information such as geological conditions, conventionally used bit (a manufacturer), size of passing through bit gauge and hammer type; |  |

|                  |
|------------------|
| Name of preparer |
| Phone number     |

# ULTRA MAXBIT VENTURI MODEL

## Your best partner for drilling in sensitive ground !

- The Flushing air doesn't hit the drilled hole directly.
- Minimal air leakage into the formation won't enlarge the drilled borehole.
- The Reverse flushing causes a vacuum effect to remove the cuttings.
- The Efficient flushing and groove designed by CAE simulation and analysis.

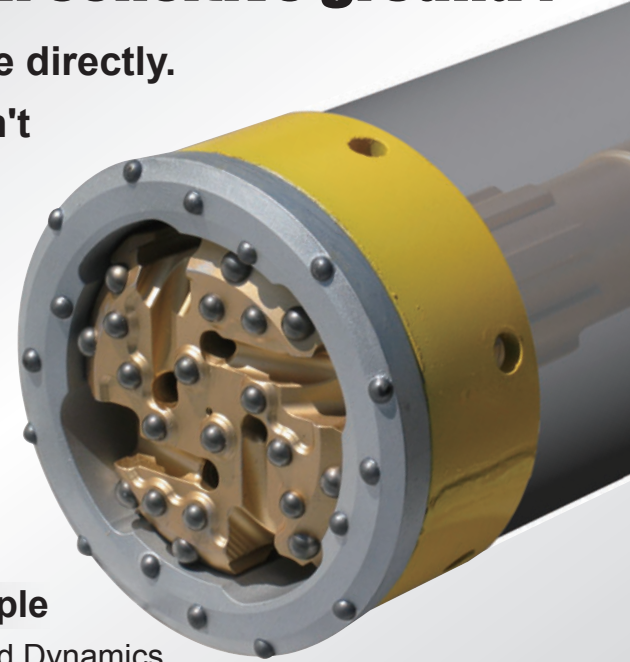

### Air Flushing Simulation and Application Example

Our Flushing Technology confirmed by Computational Fluid Dynamics supply you the best solution for drilling in sensitive ground.

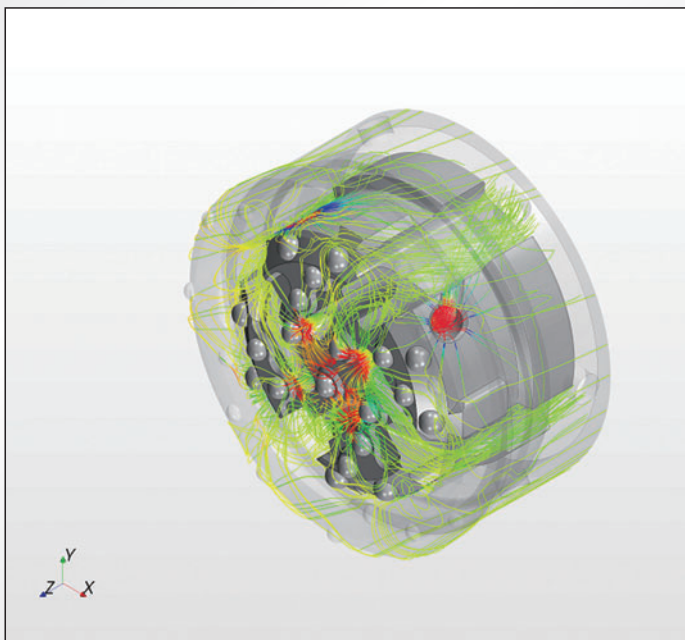

Air Flushing Simulation



Application Example

### Systems

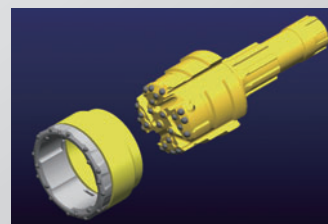

Standard System

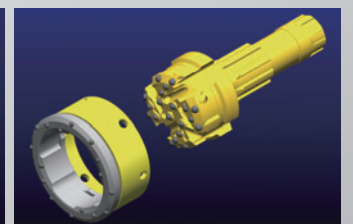

Big Bore System

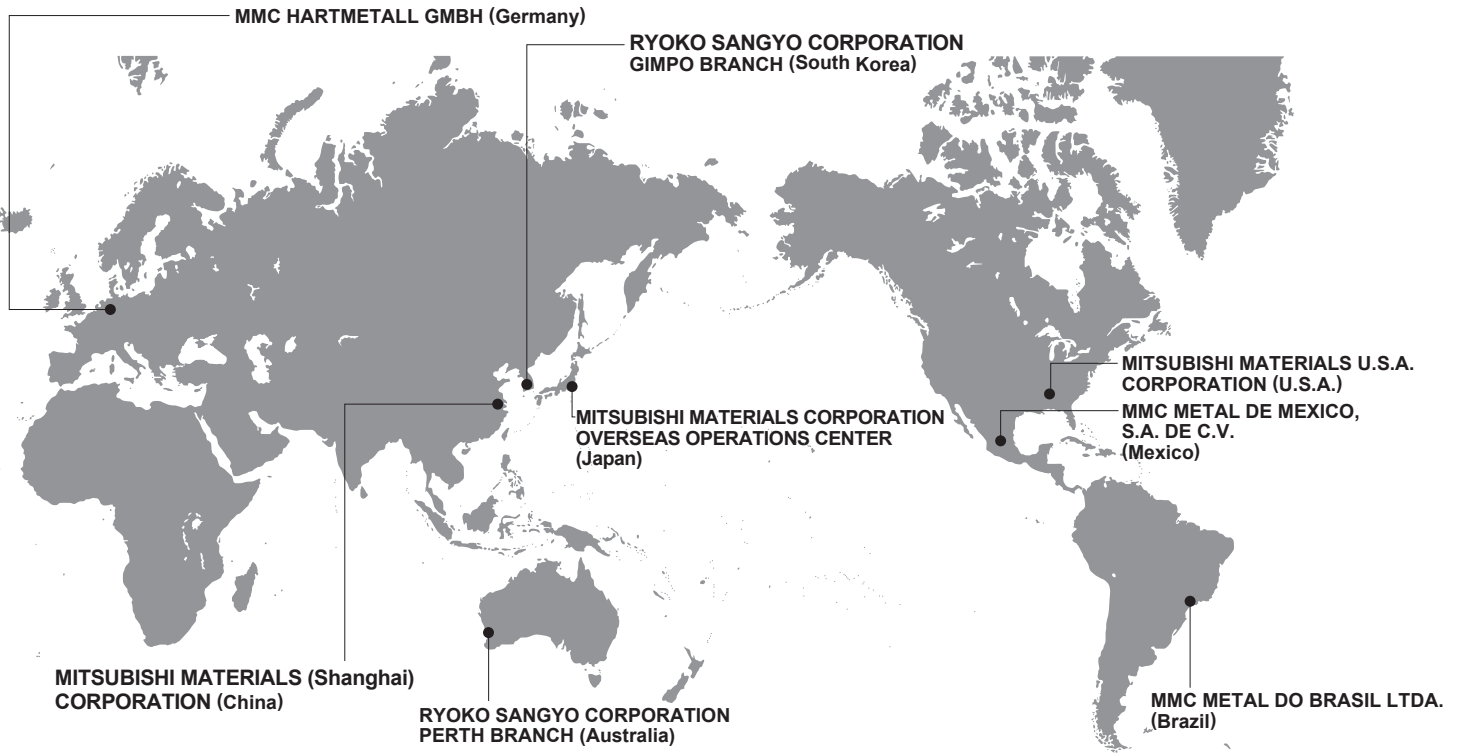

## MITSUBISHI MATERIALS CORPORATION

JAPAN / ROCK TOOLS **MITSUBISHI MATERIALS CORPORATION  
OVERSEAS OPERATIONS CENTER**  
KFC bldg., 8F, 1-6-1, Yokoami, Sumida-ku, Tokyo 130-0015, Japan  
TEL +81-3-5819-8723 FAX +81-3-5819-5259  
E-Mail: [rocktool@mmc.co.jp](mailto:rocktool@mmc.co.jp)

### Subsidiaries of MITSUBISHI MATERIALS CORPORATION

|         |   |             |   |
|---------|---|-------------|---|
| U.S.A.  | <b>MITSUBISHI MATERIALS U.S.A. CORPORATION</b><br><b>Rock Tools Office</b><br>2690 Salisbury Highway, Statesville, NC 28677, U.S.A<br>TEL +1-800-423-1358 FAX +1-888-834-2248<br>E-Mail: <a href="mailto:rock@mmus.com">rock@mmus.com</a>                           | Australia   | <b>RYOKO SANGYO CORPORATION</b><br>58 Catalano Circuit Canning Vale, WA 6155 Australia<br>PO Box 1550, Canning Vale D/C, WA 6970 Australia<br>TEL +61-8-9256-4002 FAX +61-8-9256-4471<br>E-Mail: <a href="mailto:admin@ryoko.com.au">admin@ryoko.com.au</a> |
| Germany | <b>MMC HARTMETALL GMBH</b><br>Comeniusstr. 2,40670 Meerbusch, Germany<br>TEL +49-2159-9189-32 FAX +49-2159-9189-30079<br>E-Mail: <a href="mailto:eric-mmc@wanadoo.fr">eric-mmc@wanadoo.fr</a>   | South Korea | <b>RYOKO SANGYO CORPORATION</b><br>761, Jiwoi-Ri, Pattan-Myeon, Hwaseong-Si,<br>Gyeonggi-Do 445-917, Korea<br>TEL +82-31-8059-1895 FAX +82-31-8059-1897   |
| Brazil  | <b>MMC METAL DO BRASIL LTDA.</b><br>Rua Cincinato Braga, 340 13º andar. Bela Vista-<br>CEP 01333-010 São Paulo-SP., BRASIL<br>TEL +55-11-3262-5095 FAX +55-11-3285-4906<br>E-Mail: <a href="mailto:mnbr@mnbr.com.br">mnbr@mnbr.com.br</a>                           | China       | <b>MITSUBISHI MATERIALS (Shanghai) CORPORATION</b><br>Room 3905, UNITED PLAZA 1468, Nanjing Road West,<br>Shanghai, 200040 China<br>TEL +86-21-6235-0745 FAX +86-21-6235-0741   |
| Mexico  | <b>MMC METAL DE MEXICO S.A. DE C.V.</b><br>Av. La Canada No.16 Parque Industrial Bernardo Quintana<br>El marques, Queretaro.<br>TEL +52-442-221-6136 +52-442-221-6137<br>FAX +52-442-221-6134<br>E-Mail: <a href="mailto:gonzalez@mmcex.com">gonzalez@mmcex.com</a> |             |   |

<http://mrt.mitsubishicarbide.com>

